



650V

Frame 1, 2 & 3

HA467649U003 Issue 2
Product Manual

aerospace
climate control
electromechanical
filtration
fluid & gas handling
hydraulics
pneumatics
process control
sealing & shielding



ENGINEERING YOUR SUCCESS.



650V AC Drive

Frame 1, 2 & 3

Product Manual

HA467649U003 Issue 2

Compatible with Version 5.x Software onwards

2013 Parker Hannifin Manufacturing Ltd.

All rights strictly reserved. No part of this document may be stored in a retrieval system, or transmitted in any form or by any means to persons not employed by a Parker SSD Drives company without written permission from Parker SSD Drives, a division of Parker Hannifin Ltd. Although every effort has been taken to ensure the accuracy of this document it may be necessary, without notice, to make amendments or correct omissions. Parker SSD Drives cannot accept responsibility for damage, injury, or expenses resulting therefrom.

WARRANTY

The general terms and conditions of sale of goods and/or services of Parker Hannifin Europe Sarl, Luxembourg, Switzerland Branch, Etoy, apply to this product unless otherwise agreed. The terms and conditions are available on our website www.parker.com/terms andconditions/switzerland

FAILURE OR IMPROPER SELECTION OR IMPROPER USE OF THE PRODUCTS DESCRIBED HEREIN OR RELATED ITEMS CAN CAUSE DEATH, PERSONAL INJURY AND PROPERTY DAMAGE.

This document and other information from Parker-Hannifin Corporation, its subsidiaries and authorized distributors provide product or system options for further investigation by users having technical expertise.

The user, through its own analysis and testing, is solely responsible for making the final selection of the system and components and assuring that all performance, endurance, maintenance, safety and warning requirements of the application are met. The user must analyze all aspects of the application, follow applicable industry standards, and follow the information concerning the product in the current product catalog and in any other materials provided from Parker or its subsidiaries or authorized distributors.

To the extent that Parker or its subsidiaries or authorized distributors provide component or system options based upon data or specifications provided by the user, the user is responsible for determining that such data and specifications are suitable and sufficient for all applications and reasonably foreseeable uses of the components or systems.

Safety Information



Requirements

IMPORTANT: Please read this information BEFORE installing the equipment.

Intended Users

This manual is to be made available to all persons who are required to install, configure or service equipment described herein, or any other associated operation.

The information given is intended to highlight safety issues, EMC considerations, and to enable the user to obtain maximum benefit from the equipment.

Complete the following table for future reference detailing how the unit is to be installed and used.

INSTALLATION DETAILS	
Model Number <i>(see product label)</i>	
Where installed <i>(for your own information)</i>	
Unit used as a: <i>(refer to Certification for the Inverter)</i>	<input type="checkbox"/> Component <input type="checkbox"/> Relevant Apparatus
Unit fitted:	<input type="checkbox"/> Wall-mounted <input type="checkbox"/> Enclosure



Application Area

The equipment described is intended for industrial motor speed control utilising DC motors, AC induction or AC synchronous machines

Personnel

Installation, operation and maintenance of the equipment should be carried out by qualified personnel. A qualified person is someone who is technically competent and familiar with all safety information and established safety practices; with the installation process, operation and maintenance of this equipment; and with all the hazards involved.

Product Warnings

 Caution Risk of electric shock	 Caution Refer to documentation	 Earth/Ground Protective Conductor Terminal
--	--	--

Safety Information



Hazards

DANGER! - Ignoring the following may result in injury

1. This equipment can endanger life by exposure to rotating machinery and high voltages.
2. The equipment must be permanently earthed due to the high earth leakage current, and the drive motor must be connected to an appropriate safety earth.
3. Ensure all incoming supplies are isolated before working on the equipment. Be aware that there may be more than one supply connection to the drive.
4. There may still be dangerous voltages present at power terminals (motor output, supply input phases, DC bus and the brake, where fitted) when the motor is at standstill or is stopped.
5. For measurements use only a meter to IEC 61010 (CAT III or higher). Always begin using the highest range. CAT I and CAT II meters must not be used on this product.
6. Allow at least 5 minutes for the drive's capacitors to discharge to safe voltage levels (<50V). Use the specified meter capable of measuring up to 1000V dc & ac rms to confirm that less than 50V is present between all power terminals and earth.
7. Unless otherwise stated, this product must NOT be dismantled. In the event of a fault the drive must be returned. Refer to "Routine Maintenance and Repair".

WARNING! - Ignoring the following may result in injury or damage to equipment

SAFETY

Where there is conflict between EMC and Safety requirements, personnel safety shall always take precedence.

- Never perform high voltage resistance checks on the wiring without first disconnecting the drive from the circuit being tested.
- Whilst ensuring ventilation is sufficient, provide guarding and /or additional safety systems to prevent injury or damage to equipment.
- When replacing a drive in an application and before returning to use, it is essential that all user defined parameters for the product's operation are correctly installed.
- All control and signal terminals are SELV, i.e. protected by double insulation. Ensure all external wiring is rated for the highest system voltage.
- Thermal sensors contained within the motor must have at least basic insulation.
- All exposed metalwork in the Inverter is protected by basic insulation and bonded to a safety earth.
- RCDs are not recommended for use with this product but, where their use is mandatory, only Type B RCDs should be used.

EMC

- In a domestic environment this product may cause radio interference in which case supplementary mitigation measures may be required.
- This equipment contains electrostatic discharge (ESD) sensitive parts. Observe static control precautions when handling, installing and servicing this product.
- This is a product of the restricted sales distribution class according to IEC 61800-3. It is designated as "professional equipment" as defined in EN61000-3-2. Permission of the supply authority shall be obtained before connection to the low voltage supply.

CAUTION!

APPLICATION RISK

- The specifications, processes and circuitry described herein are for guidance only and may need to be adapted to the user's specific application. We can not guarantee the suitability of the equipment described in this Manual for individual applications.

RISK ASSESSMENT

Under fault conditions, power loss or unintended operating conditions, the drive may not operate as intended.

In particular:

- Stored energy might not discharge to safe levels as quickly as suggested, and can still be present even though the drive appears to be switched off
- The motor's direction of rotation might not be controlled
- The motor speed might not be controlled
- The motor might be energised

A drive is a component within a drive system that may influence its operation or effects under a fault condition. Consideration must be given to:

- Stored energy
- Supply disconnects
- Sequencing logic
- Unintended operation

Contents

Contents

Page

CHAPTER 1 GETTING STARTED **1-1**

Introduction	1-1
Equipment Inspection	1-1
Storage and Packaging	1-1
About this Manual	1-1

CHAPTER 2 AN OVERVIEW OF THE DRIVE **2-1**

Component Identification	2-1
---------------------------------------	------------

CHAPTER 3 INSTALLING THE DRIVE **3-1**

Mechanical Installation	3-1
Mounting the Drive.....	3-1
Ventilation	3-1
Electrical Installation	3-2
Wiring Instructions.....	3-2
Connection Diagram.....	3-3
Optional Equipment	3-6

CHAPTER 4 OPERATING THE DRIVE **4-1**

Pre-Operation Checks	4-1
Initial Start-up Routines	4-1
Local Control Operation.....	4-2
Remote Control Operation	4-2
Set-up as an Open-loop drive (V/F Mode)	4-3
Set-up using the Sensorless Vector Mode	4-3
Tuning the Drive to Your System.....	4-5

CHAPTER 5 THE KEYPAD **5-1**

Controlling the Drive using the Keypad	5-1
Control Key Definitions	5-1
Display Indications	5-2
Drive Status Indications.....	5-2
Quick Application Selection	5-2
Selecting the Menu Detail	5-3
The DIAGNOSTICS Menu	5-3
The Menu System	5-4
Special Menu Features	5-5
How To Change a Parameter Value	5-5
Resetting to Factory Defaults (2-button reset).....	5-5
Changing the Default Operating Frequency	5-5
Selecting Local or Remote Control.....	5-6

Contents

<i>Contents</i>	<i>Page</i>
Changing Direction in Local Control	5-6
Password Protection	5-7
CHAPTER 6 PROGRAMMING YOUR APPLICATION	6-1
MMI Parameters	6-1
Product-Related Default Values	6-16
CHAPTER 7 TRIPS AND FAULT FINDING	7-1
Trips	7-1
Trip Warning Message	7-1
What Happens when a Trip Occurs.....	7-1
Resetting a Trip Condition.....	7-1
Using the Keypad to Manage Trips.....	7-1
Hexadecimal Representation of Trips.....	7-5
Fault Finding	7-6
CHAPTER 8 ROUTINE MAINTENANCE & REPAIR	8-1
Routine Maintenance	8-1
Repair	8-1
Saving Your Application Data	8-1
Returning the Unit to Parker SSD Drives.....	8-1
Disposal	8-1
CHAPTER 9 TECHNICAL SPECIFICATIONS	9-1
Understanding the Product Code	9-1
Environmental Details.....	9-3
Power Details.....	9-3
Electrical Ratings	9-4
Supply Short Circuit Rating.....	9-5
User Relay	9-5
Analog Inputs/Outputs	9-5
Analog Outputs	9-5
Digital Inputs	9-6
Digital Outputs	9-6
Cabling Requirements for EMC Compliance	9-6
Internal Dynamic Braking Circuit.....	9-7
External Brake Resistor.....	9-7
Supply Harmonic Analysis (230V filtered)	9-8
Supply Harmonic Analysis (400V filtered)	9-9
Supply Harmonic Analysis (230V unfiltered).....	9-10
Supply Harmonic Analysis (400V unfiltered).....	9-11
CHAPTER 10 CERTIFICATION FOR THE DRIVE	10-1
Requirements for EMC Compliance	10-1
Earthing Requirements.....	10-1
Requirements for UL Compliance	10-1

Contents

<i>Contents</i>	<i>Page</i>
European Directives and the CE Mark	10-3
CE Marking for Low Voltage Directive	10-3
CE Marking for EMC - Who is Responsible?.....	10-3
EMC Compliance	10-3
Certificates.....	10-4
CHAPTER 10 CERTIFICATION FOR THE DRIVE	10-1
Requirements for EMC Compliance	10-1
Earthing Requirements.....	10-1
Requirements for UL Compliance	10-1
European Directives and the CE Mark	10-3
CE Marking for Low Voltage Directive	10-3
CE Marking for EMC - Who is Responsible?.....	10-3
EMC Compliance	10-3
Certificates.....	10-4
CHAPTER 11 SERIAL COMMUNICATIONS	11-1
Connection to the P3 Port	11-1
CHAPTER 12 APPLICATIONS	12-1
The Default Application	12-1
How to Load an Application	12-1
Application Description	12-1
Control Wiring for Applications.....	12-1
Application 1 : Basic Speed Control (default)	12-2
Application 2 : Auto/Manual Control	12-4
Application 3 : Preset Speeds.....	12-6
Application 4 : Raise/Lower Trim.....	12-8
Application 5 : PID	12-10
Application 6 : Auxilliary Comms	12-12

Chapter 1 GETTING STARTED

Introduction

The 650V Series AC Drive provides simple, compact, and low-cost speed control for 3-phase induction motors

This manual describes the low-power end of the 650V product range for the following motor power ratings:

	Nominal Input Voltage	Phase	Drive Power	
Frame 1	230V	1	0.25 – 0.75kW	0.3 - 1.0 Hp
Frame 2	230V	1	1.1 – 1.5kW	1.5 - 2.0 Hp
Frame 2	400V	3	0.37 – 2.2kW	0.5 - 3.0 Hp
Frame 3	230V	1	2.2kW	3.0 Hp
Frame 3	230V	3	2.2 - 4.0 kW	3.0 - 5.0 Hp
Frame 3	400V	3	3.0 – 7.5kW	4.0 - 10.0 Hp

The drive features:

- Local or Remote mode operation
- SELV control terminals (Safe Extra Low Volts)
- Intelligent monitoring strategy to avoid nuisance tripping
- In-built protection of the unit against overloads, excessive voltages, phase-to-phase and phase-to-earth short circuits
- An internal RFI filter is fitted as standard
- An internal dynamic brake switch for connection to an external resistor (Frame 3: 230V, and 400V units only)
- Quiet operation
- Controlling the unit locally using the 6511 Keypad gives access to parameters, diagnostic messages, trip settings and full application programming a connection to a pc is required along with the drive software tool. Other features also become available, such as the advanced sensorless vector control scheme which gives high torque, low speed operation; selectable switching frequencies; and a unique Quiet Pattern control system that minimises audible noise from the motor.

Note: *Do not attempt to control motors whose rated current is less than 50% of the drive rated current. Poor motor control or Autotune problems may occur if you do*

Equipment Inspection

- Check for signs of transit damage
- Check the drive is suitable for your requirements by reading the Product Code on the rating label. Refer to Chapter 9: “Technical Specifications” - Understanding the Product Code.

If the unit is damaged, refer to Chapter 8: “Routine Maintenance and Repair” for information on returning damaged goods.

Storage and Packaging

Save the packaging in case of return. Improper packaging can result in transit damage.

If the unit is not being installed immediately, store the unit in a well-ventilated place away from high temperatures, humidity, dust or metal particles.

About this Manual

This manual is intended for use by the installer, user and programmer of the drive. It assumes a reasonable level of understanding in these three disciplines.

Note: *Please read all Safety Information before proceeding with the installation and operation of this unit.*

It is important that you pass the manual on to any new user of this unit.

1-2 Getting Started

Software Product Manual

An accompanying Software Product Manual is available for download from the Parker SSD Drives website: www.parker.com/SSD

Chapter 2 AN OVERVIEW OF THE DRIVE

Component Identification

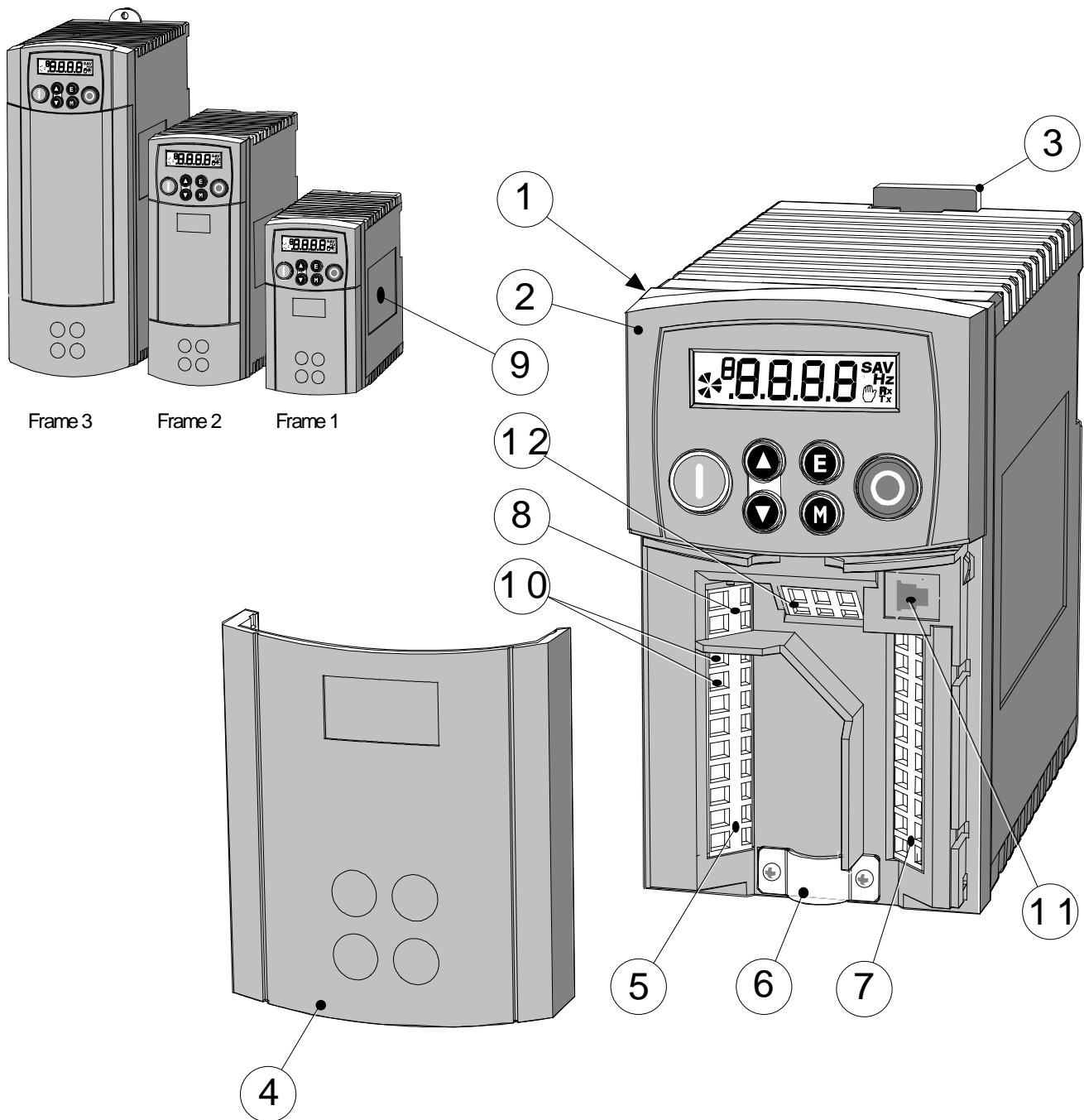

Figure 2-1 View of Component Parts (Frame 1 illustrated)

1	Main drive assembly	7	Control terminals
2	Keypad	8	Volt-free relay contacts
3	DIN clip/fixing bracket	9	Product rating label
4	Terminal cover	10	Motor thermistor terminals
5	Power terminals	11	RS232 programming port - P3
6	Motor cable screen clamp	12	Encoder/digital inputs

3-1 Installing the Drive

Chapter 3 INSTALLING THE DRIVE

IMPORTANT: Read Chapter 10: "Certification for the Drive" before installing this unit.

Mechanical Installation

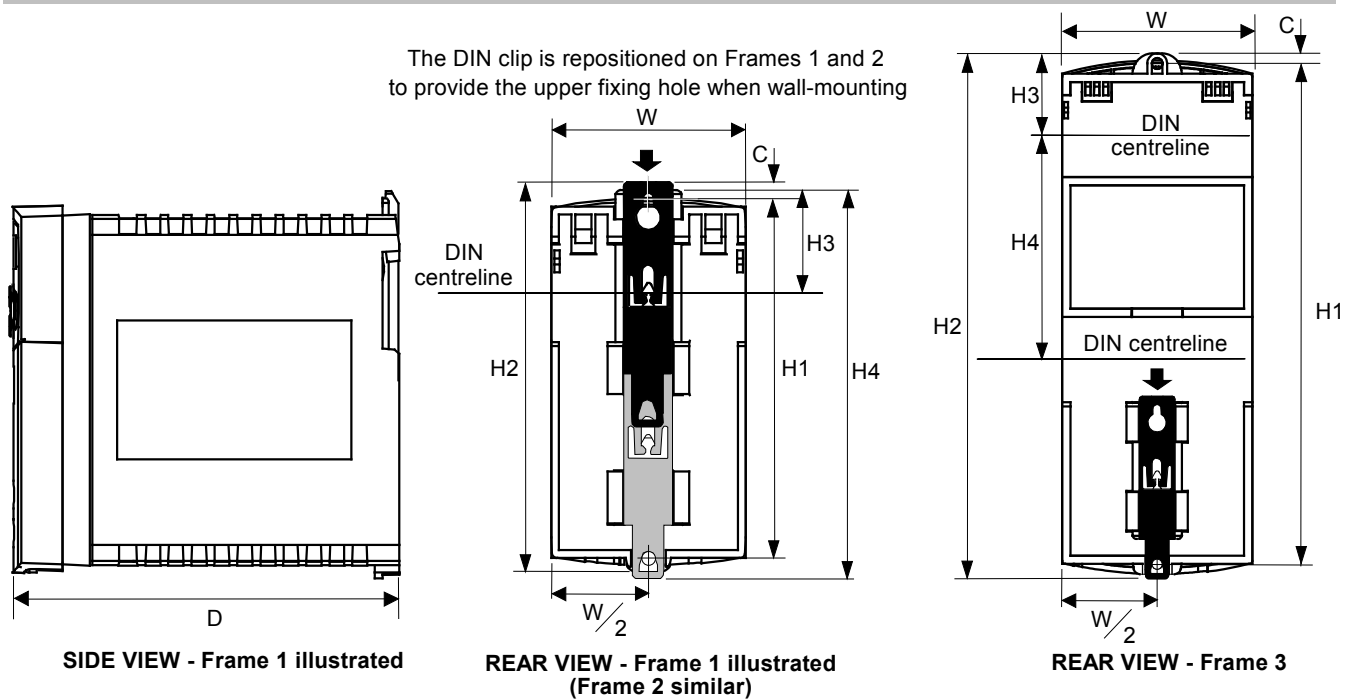

	Fixing	Torque	Weight	H1 Fixing Centres	H2	H3	H4	C	W	D
Frame 1	M4	1.5Nm	0.85kg (2 lbs)	132 (5.2")	143 (5.6")	35 (1.4")	139 (5.5")	6 (0.2")	73 (2.9")	142 (5.6")
Frame 2	M5	3.0Nm	1.4kg (3 lbs)	188 (7.4")	201 (7.9")	35 (1.4")	194 (7.7")	6.5 (0.24")	73 (2.9")	173 (6.8")
Frame 3	M5	3.0Nm	2.7kg (6 lbs)	242 (9.5")	260 (10.2")	38 (1.5")	112 (4.4")	5 (0.2")	96 (3.8")	200 (7.9")

Dimensions are in millimetres (inches)

Mounting the Drive

To maintain compliance with European Electrical Safety Standard VDE0160(1994)/EN50178 (1998) the unit must be mounted inside a control cubicle that requires a tool for opening. The cubicle should provide 15dB attenuation to radiated emissions between 30-100MHz.

Mount the drive vertically on a solid, flat, non-flammable, vertical surface. It can be panel-mounted, or rail-mounted on a rail complying with EN50022 (35mm DIN).

DIN Mounting

To DIN mount the unit, hang the unit on the top DIN rail and push the unit onto the bottom DIN rail until it snaps in to position. Secure with a lower screw fixing. To release the unit, use a flat bladed screwdriver as shown.

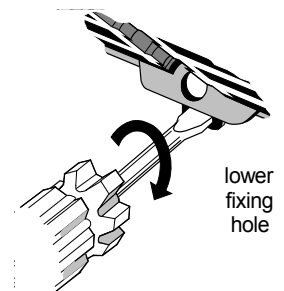

Ventilation

Maintain a minimum air clearance for ventilation of 100mm (4 inches) above and below the unit. When mounting two or more 650V units together, these clearances are additive. Ensure that the mounting surface is normally cool. Be aware that adjacent equipment may generate heat and also have clearance requirements. Provided the minimum clearance for ventilation is maintained, 650V drives may be mounted side-by-side.

Electrical Installation

IMPORTANT: Read the Safety Information on page Cont. 2 before proceeding.

Wiring Instructions

Local Control Wiring

This is the simplest installation. Every new drive will operate in Local Control when first powered-up. The keypad is used to start and stop the drive.

Refer to the Connection Diagram and install the:

- Thermistor cable, or link/jumper terminals TH1A and TH1B (we recommend you do use a thermistor)
- Motor cable
- Supply cable
- Follow the earthing/grounding and screening advice Refer to Chapter 4: "Operating the Drive"- Local Control Operation.

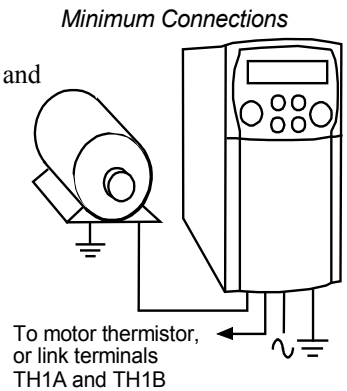

Remote Control Wiring

If operating in Remote Control you will use your control panel to start and stop the drive, via a speed potentiometer and switches or push-buttons.

Your wiring of the control terminals will be governed by the Application you use: refer to Chapter 12 for an explanation of the various Applications you can select and the appropriate control wiring. Application 1 is the default Application.

The diagram below shows the **minimum** connections to operate the drive for single-wire (switch) starting, and push-button starting. Other control connections for your Application are shown in Chapter 12 and can be made to suit your system.

Referring to the Connection Diagram:

- Follow the instructions for Local Control Wiring, as detailed above
- Install using minimum connections (suitable for Application 1 only), or refer to Chapter 12 and install the appropriate control wiring for your system

Minimum Connections for Application 1:

Single Wire Starting

Push-Button Starting

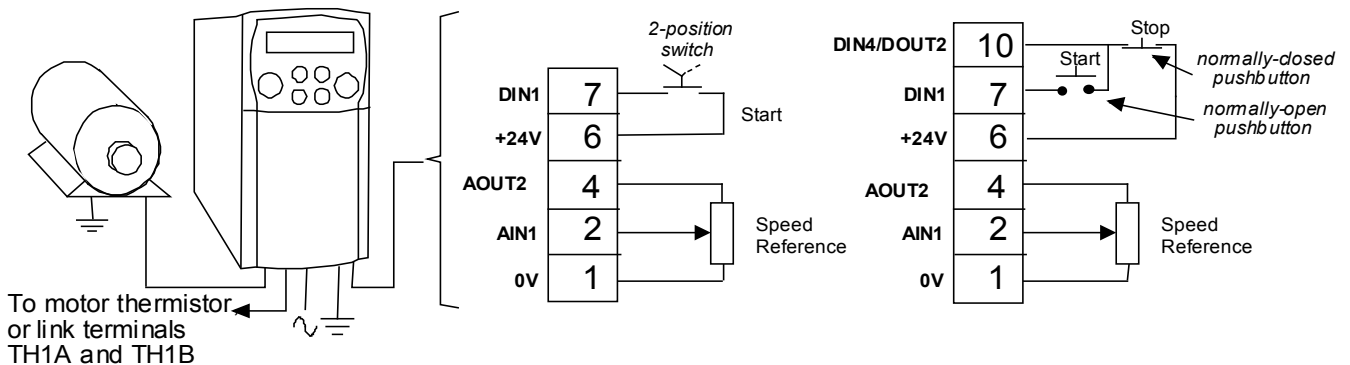

Note: You can still operate the drive in Local mode, if necessary, with any Application selected.

Refer to Chapter 4: "Operating the Drive" and follow the relevant instructions for Single Wire Starting or Push-Button Starting.

WARNING!

This product is designated as "professional equipment" as defined in EN61000-3-2. Where enforced, permission of the supply authority shall be obtained before connection to the low voltage domestic supply.

Ensure that all wiring is electrically isolated and cannot be made "live" unintentionally by other personnel.

The drive is suitable for use with both earth referenced supplies (TN) and non-earth referenced supplies (IT) when fitted with an internal ac supply EMC filter.

3-3 Installing the Drive

Connection Diagram

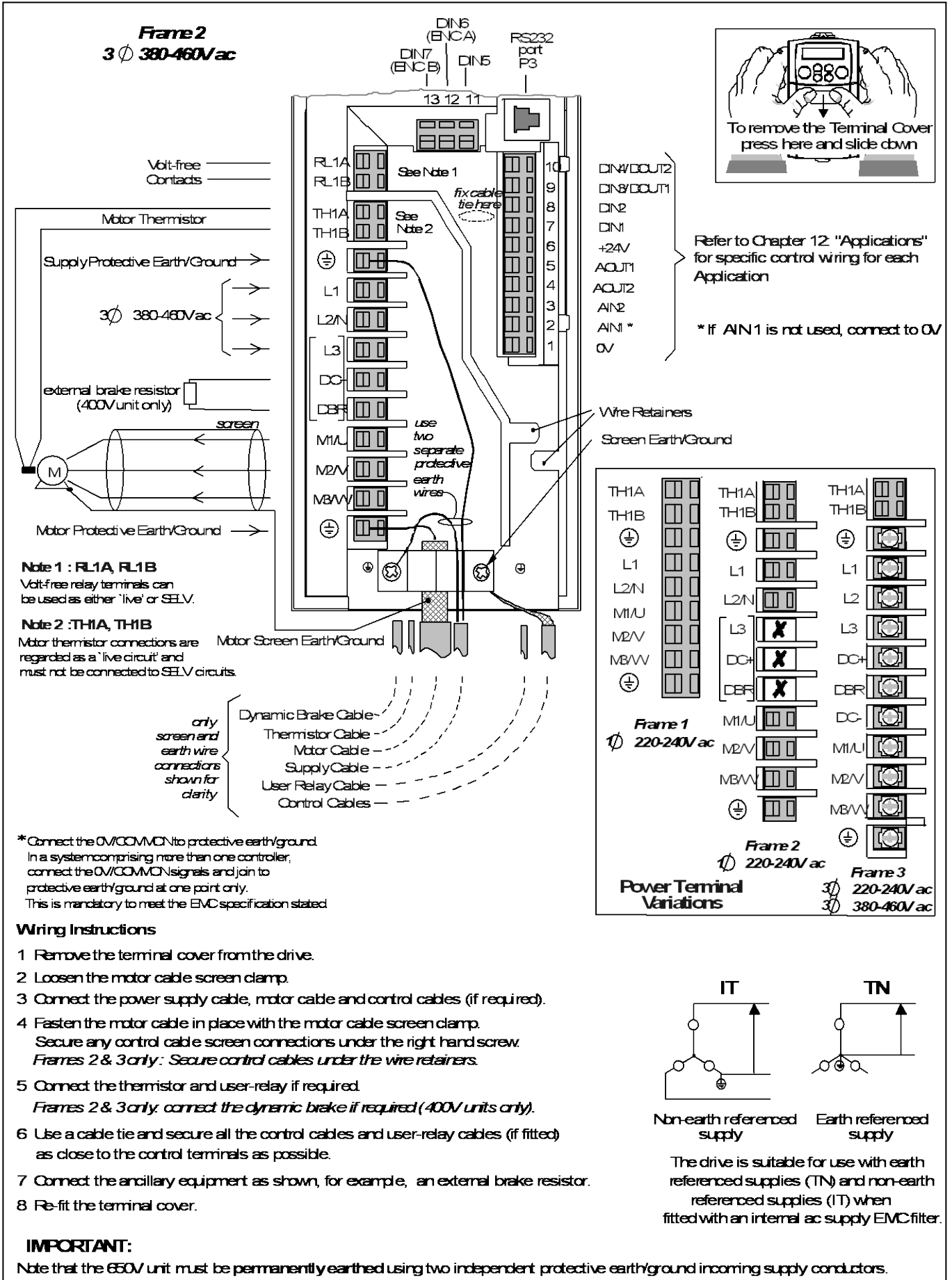



Control Wiring Connections

Terminal (SELV)	Name	Application 1 Default Function (for other Applications refer to Chapter 12: "Applications")	Range
P3	P3	RS232 port for use with remote-mounted RS232 keypad or programming PC	-
RL1A	User Relay	Volt-free contact	0-250Vac/24Vdc 4A
RL1B	User Relay	Volt-free contact	0-250Vac/24Vdc 4A
13	DIN7 (ENC B)	Configurable digital input	0-24V
12	DIN6 (ENC A)	Configurable digital input	0-24V
11	DIN5	Not Coast Stop - configurable digital input: 0V = Stop, 24V = Coast Stop	0-24V
10	DIN4/ DOUT2	Configurable digital input/output Not Stop (input): 0V = No latching of Run (DIN1), 24V = Run latched	0-24V source open collector *
9	DIN3/ DOUT1	Jog – configurable digital input: 0V = Stop, 24V = Jog	0-24V
8	DIN2	Direction – configurable digital input: 0V = Forward, 24V = Reverse	0-24V
7	DIN1	Run Forward – configurable digital input: 0V=Stop, 24V=Run	0-24V
6	+24V	24V supply for digital I/O	*
5	AOUT1	Ramp Output – configurable analog output (10mA loading)	0-10V
4	AOUT2	Defaults to provide a 10V reference (10mA loading)	0-10V
3	AIN2	Speed Trim – analog input 2	0-10V, 4-20mA
2	AIN1	Speed Setpoint – analog input 1. If AIN 1 is not used, connect to 0V.	0-10V
1	0V	0V reference for analog/digital I/O	0V

* The total current available is 50mA, either individually or as the sum of outputs from terminals 6, 10 and 11.

Power Wiring Connections

Terminal	Description	Function	Range	
			200V 1-Phase	200V/400V 3-Phase
TH1A	Thermistor	Connection to motor thermistor	It is good practice to protect motors by fitting temperature sensitive resistors. A typical resistance (up to a reference temperature of 125°C) is 200Ω, rising rapidly to 2000Ω above this temperature. Connect devices in series between TH1A and TH1B. Link the terminals if temperature sensors are not used.	
TH1B	Thermistor	Connection to motor thermistor		
	Reference Terminal	Supply protective earth (PE). This terminal must be connected to a protective (earth) ground for permanent earthing .		
L1 *	Power Input	Single and three phase live connection	220/240V ac ±10% rms with respect to L2/N. 50-60Hz (IT/TN)	220/240V or 380/460V ac ±10% rms with respect to L2, L3 phase-to-phase. 50-60Hz (IT/TN)
L2/N * L2	Power Input	Single phase neutral (or L2 three phase live connection)	220/240V ac ±10% with respect to L1. 50-60Hz (IT/TN)	220/240V or 380/460V ac ±10% with respect to L1, L3. 50-60Hz (IT/TN)
L3	Power Input	Three phase live connection	Not applicable	220/240V or 380/460V ac ±10% with respect to L1, L2. 50-60Hz (IT/TN)
DC-	<i>No user connection</i>			
DC+	Dynamic Brake	Connection to external brake resistor	Not applicable	Frame 2 (high volt only) & 3. See "Internal Dynamic Brake Switch" table
DBR	Dynamic Brake	Connection to external brake resistor	Not applicable	Frame 2 (high volt only) & 3. See "Internal Dynamic Brake Switch" table
M1/U M2/V M3/W	Motor Outputs	Connection for motor	Motor rated at: 0 to 220/240V ac 0 to 240Hz	Motor rated at: 0 to 220/240V or 0 to 380/460V ac 0 to 240Hz
	Reference Terminal	Supply protective earth (PE). This terminal must be connected to a protective (earth) ground for permanent earthing .		

3-5 Installing the Drive

Terminal Block Acceptance Sizes

Wire sizes should be chosen with respect to the operating conditions and your local National Electrical Safety Installation Requirements. Local wiring regulations always take precedence.

Frame Size	Power Terminals (maximum wire size)	Brake Terminals (maximum wire size)	Thermistor/Control Terminals (maximum wire size)
Frame 1 230V	2.5mm ² /12 AWG	Not Applicable	2.5mm ² /12 AWG
Frame 2 230V	2.5mm ² /12 AWG	Not Applicable	2.5mm ² /12 AWG
Frame 2 400V	2.5mm ² /12 AWG	2.5mm ² /12 AWG	2.5mm ² /12 AWG
Frame 3 230V	6.0mm ² /10 AWG	6.0mm ² /10 AWG	2.5mm ² /12 AWG
Frame 3 400V	6.0mm ² /10 AWG	6.0mm ² /10 AWG	2.5mm ² /12 AWG

Power Wiring

Note: For specified EMC emission and immunity performance, install to EMC Installation Instructions. Refer to Chapter 10: "Certification for the Drive" - for more information

Terminal tightening torque for Frame 3 power connections is 20 lb.in (2.26Nm).

Protect the incoming mains supply using the specified fuse, or RCD circuit breaker Type B.

IMPORTANT: We do not recommend the use of circuit breakers (e.g. RCD, ELCB, GFCI), however, where their use is mandatory, they must:

- Operate correctly with dc and ac protective earth currents (i.e. type B RCDs as in Amendment 2 of IEC755).
- Have adjustable trip amplitude and time characteristics to prevent nuisance tripping on switch-on.

Control Wiring

Control wiring of between 0.08mm² (28AWG) and 2.5mm² (12AWG) can be used. Ensure all wiring is rated for the highest system voltage. All control terminals are SELV, i.e. double-insulated from power circuits.

Using Cage Clamp Terminals

Strip wire insulation to 5-6mm (0.20-0.24 inches), or alternatively use wire-crimps. Use a flat-bladed screwdriver, maximum blade size 3.5mm. The cage provides the correct force for a secure connection.

IMPORTANT: DO NOT lever or turn the screwdriver.

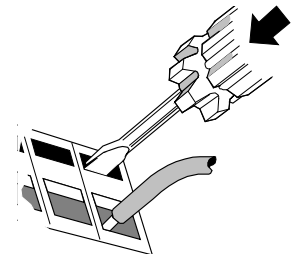

Optional Equipment

Fitting the Remote 6511 Keypad

You can remote-mount the drive-mounted Keypad using:

- the RS232 (P3) port located under the terminal cover
- A standard P3 lead, Parker SSD Part Number CM057375U300, which is used to connect the Keypad to the drive.

Two self-tapping screws are provided with the Keypad. Remove the protective film from the gasket. An enclosure rating of IP54 is achieved for the remote Keypad when correctly mounted.

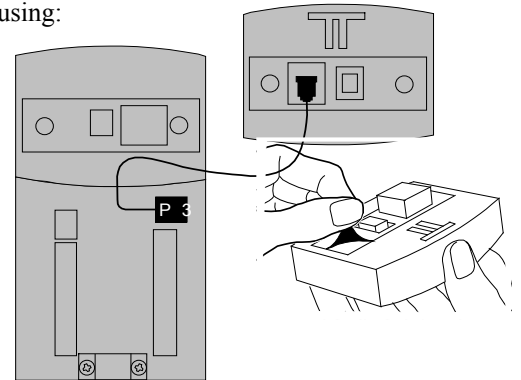

Assembly Procedure

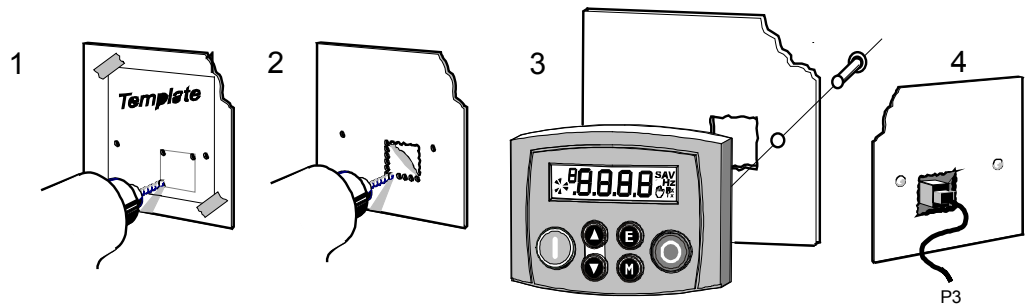

Cut-out Dimensions

The drawing below can be photocopied actual size (100%) and used as a template.

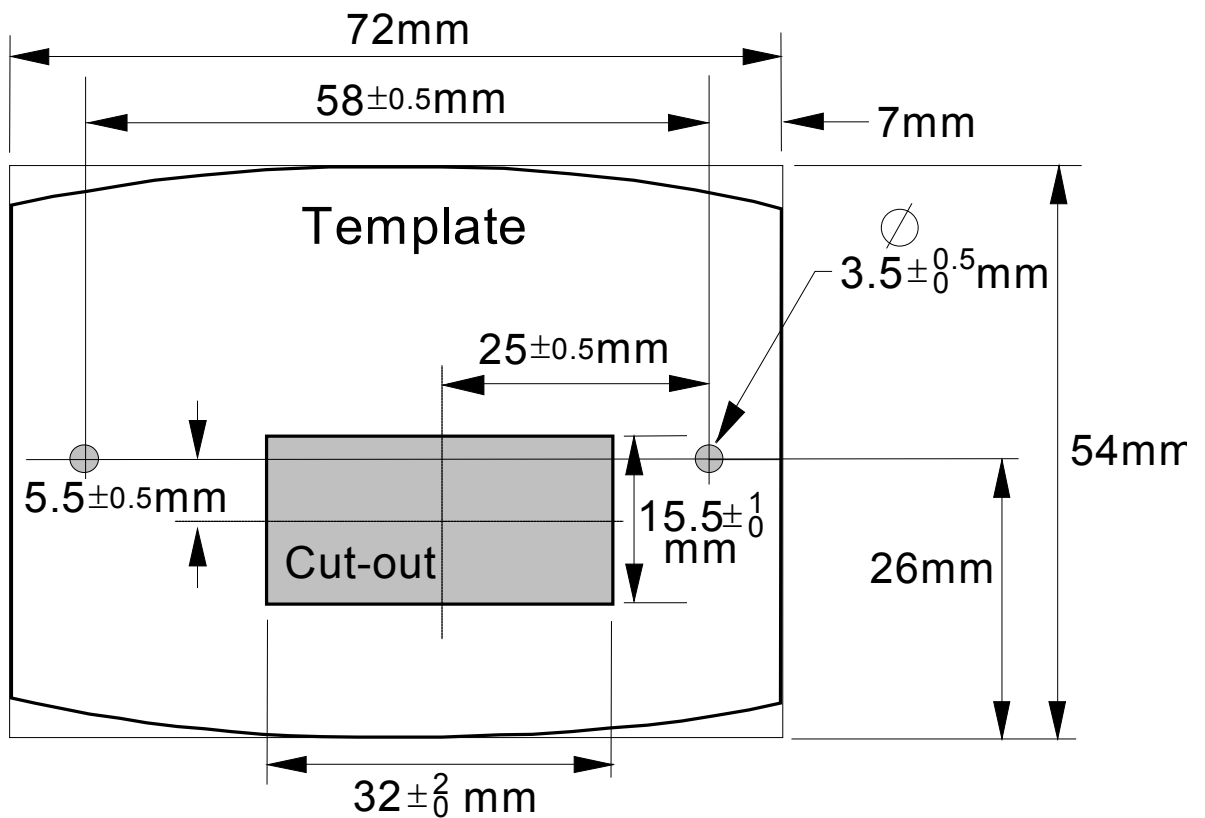

3-7 Installing the Drive

Fitting the Remote 6521/6901/6911 Keypad

The 6052 Mounting Kit is required to remote-mount a 6521 Keypad. An enclosure rating of IP54 is achieved for the remote Keypad when correctly mounted using the 6052 Mounting Kit.

6052 Mounting Kit Parts for the Remote Keypad

Tools Required

No. 2 Posidrive screwdriver.

6052 Mounting Kit					
1		1		1	Steward 28A2025-OAO
4	No. 6 x 12mm	1		3m, 4-way	

Assembly Procedure

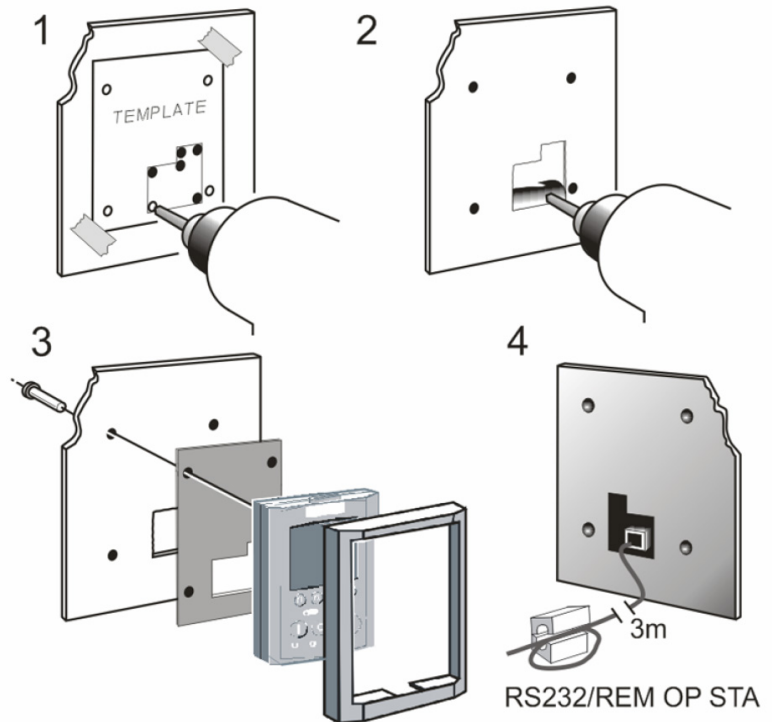

Cutout Dimensions

An actual size template is provided with the Keypad/6052 Mounting Kit.

Figure 3-1 Mounting Dimensions for the Remote-Mounted Keypad 6521/6901/6911



The 6901/6911 keypad, supplied with 690+ products, may be remote mounted and connected to the 650V drive in the same way.

6901

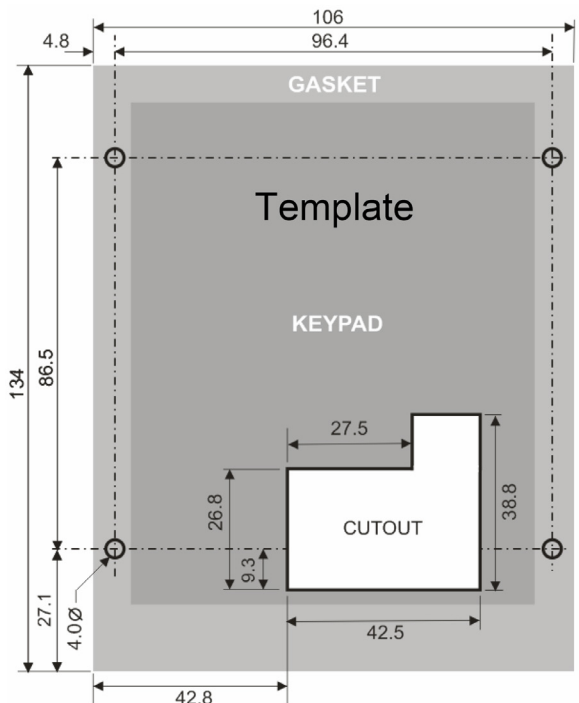

RS485/RS232 Communication Module

You can create a network of drives by linking a Master (PC/PLC) to one or more 650V drives fitted with this module.

Plug this Communication Module on to the front of the 650V drive, replacing the keypad.

It converts signals from the host 650V drive into RS485 or RS232, and vice versa, so that information can be shared between the Master and 650V drive(s).

Wiring is very simple - all connections are SELV (Safe Extra Low Voltage). Select to use RS485 or RS232 by wiring to the appropriate terminal on the module.

Note: RS485 and RS232 terminals cannot be used simultaneously.

We recommend you ground the module to the system earth using the Functional Earth terminal.

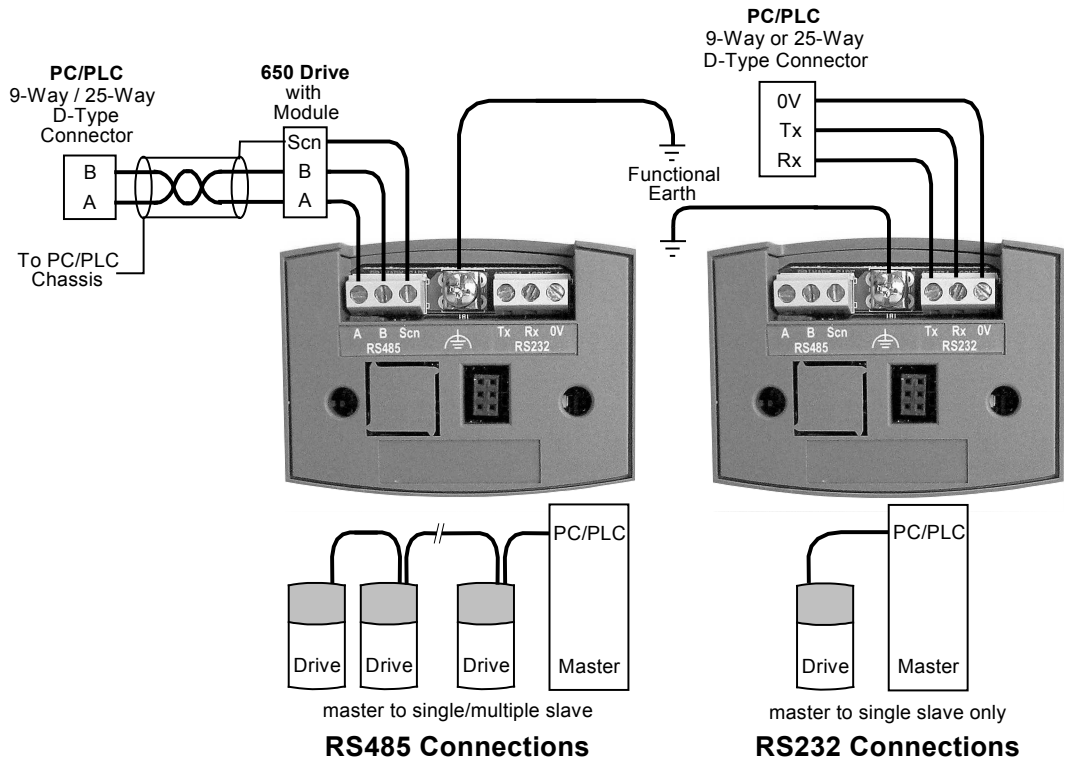

Wiring Specifications		
	RS485 Connections	RS232 Connections
Network Type	2-Wire Shielded Twisted-Pair	3-Wire Un-Shielded Cable
Connections	A=RxA/TxA, B=RxB/TxB, Shield	Rx, Tx, Ground (0V)
Signal Levels	To RS485 Standard	To RS232 Standard
Receiver Input Impedance	¼ Unit Load	3 kΩ minimum 7kΩ maximum
Maximum Cable Length	1200m (4000ft)	3 metres
Maximum Baud Rate	57.6kbaud	57.6kbaud
Maximum Number of Units	32 including slaves and masters	2: 1 master and 1 slave only

3-9 Installing the Drive

LED Indications

The module has three LEDs providing diagnostic information about the 650V host drive's 'Health', 'Receive' and 'Transmit' activity.

HEALTH = Green, Rx = Red, Tx =Red



LED Name	LED Duty	Drive State
HEALTH	SHORT FLASH	Re-configuration, or corrupted non-volatile memory at power-up
	EQUAL FLASH	Tripped
	ON	Healthy
	LONG FLASH	Braking
	OFF	No drive power, or serious hardware fault
Rx	INTERMITTENT	Indicates activity on the 'receive' line carrying data from the Master
Tx	INTERMITTENT	Indicates activity on the 'transmit' line carrying data to the Master

Configure the Drive

Before the module can be used you must configure the drive to your system. Set-up the parameters in the SERIAL menu as appropriate. Refer to Chapter 6: "Programming Your Application" - SET::SERL Menu, parameters ^SSE01 to ^SSE08.

For Tag number information refer to the 650V Software Product Manual, available on the Parker SSD Drives website: www.parker.com/ssd.

Note: This Option can only be used on drives using software version 4.1 or higher.

Encoder Connections

The drive is **only** suitable for use with single-ended encoders. Take special care wiring the encoder to the drive due to the low level of the signals.

All wiring to the drive should be made in screened cable. Use cable with an overall screen and a screen over each individual pair. To ensure compliance with the EMC Directive the overall cable screen should be connected to the drive chassis.

Recommended cable (pairs individually screened):

- Belden equivalent 8777
- SSD Drives Part Number CM052666

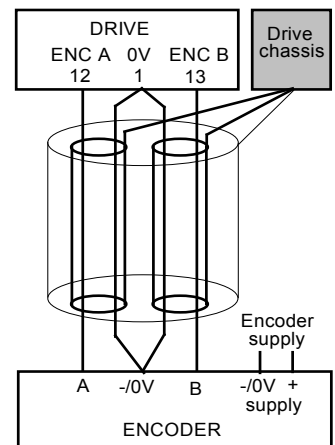

The drive will operate with 5-24V encoders. Provide the correct supply for the encoder. Do not use the 10V or 24V supply from the drive.

The maximum input frequency of terminals 12 and 13 (ENCA and ENCB) is 100kHz.

Line Choke

Cables are considered to be electrically sensitive, clean or noisy. A line choke is used to reduce harmonic emission to meet the limits of EN61000-3-2.

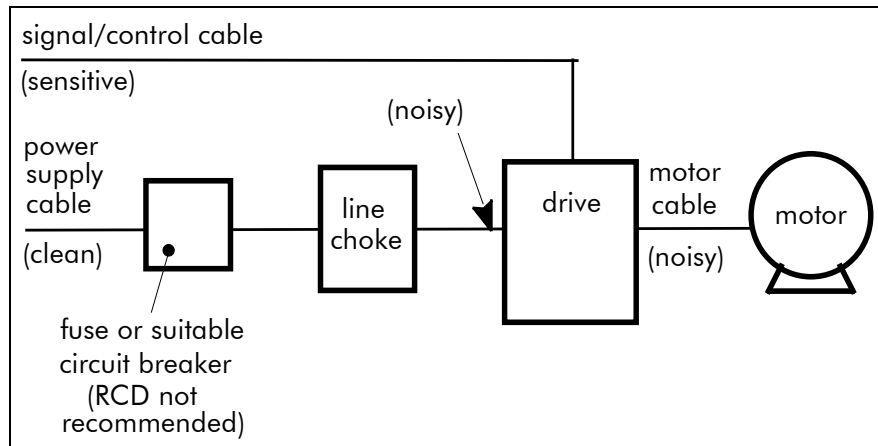

The choke is for use on the following drive:

Phase	Drive Nominal Input Voltage (V)	Drive Power (kW/hp)	Rated Current (A _{eff})	Rated Inductivity (mH)	Choke Part Number
3	400	0.37/0.5	6	4.88	CO467763U003 (Europe)

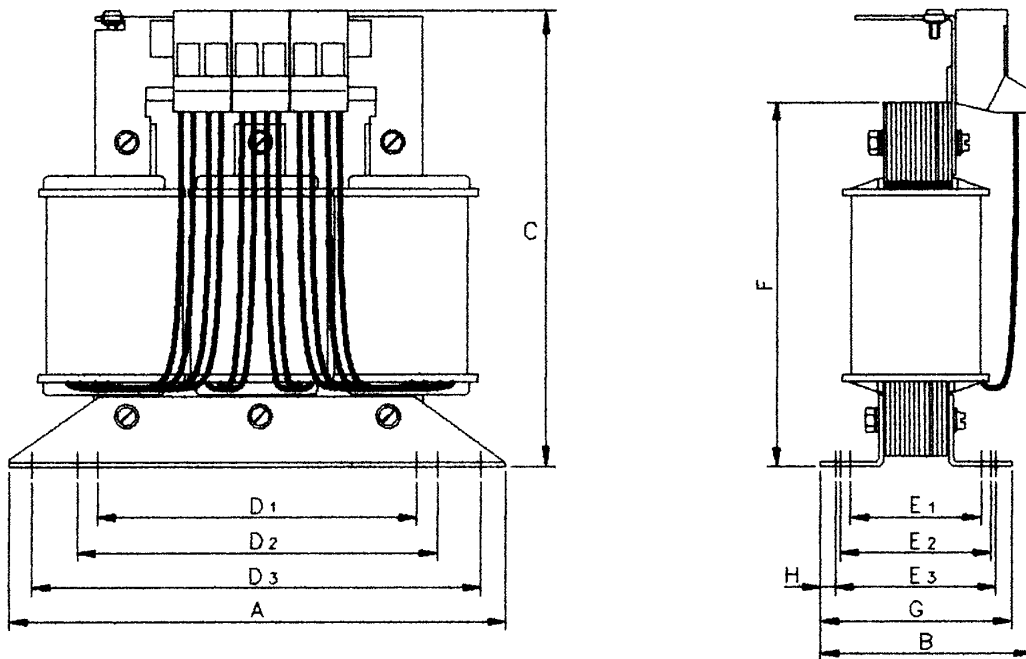

Rated Current (A _{eff})	Rated Inductivity (mH)	A (mm)	B (mm)	C (mm)	D1 (mm)	D2 (mm)	D3 (mm)	E1 (mm)	E2 (mm)	E3 (mm)	F* (mm)	G (mm)	Fixing Screws	Weight (kg/lbs)
650 Frame 2, 3-phase, 400V, 0.37kW/0.5Hp														
6	4.88	148	76	151	90	100	136	39	45	49	110	69	M4	2.1/4.63

* dimension is dependent of the air gap

Chapter 4 OPERATING THE DRIVE

Pre-Operation Checks

WARNING!

Wait for 5 minutes after disconnecting power before working on any part of the system or removing the terminal cover from the drive.

Initial checks before applying power:

- Check for damage to equipment.
- Mains power supply voltage is correct.
- Motor is of correct voltage rating and is connected in either star or delta, as appropriate.
- Check all external wiring circuits - power, control, motor and earth connections.

Note: Completely disconnect the drive before point to point checking with a buzzer, or when checking insulation with a Meggar.

- Check for loose ends, clippings, drilling swarf etc. lodged in the drive and system.
- If possible check that the motor can be turned freely, and that any cooling fans are intact and free from obstruction.

Ensure the safety of the complete system before the drive is energised:

- Ensure that rotation of the motor in either direction will not cause damage.
- Ensure that nobody else is working on another part of the system which will be affected by powering up.
- Ensure that other equipment will not be adversely affected by powering up.

Prepare to energise the drive and system as follows:

- Remove the supply fuses, or isolate using the supply circuit breaker.
- Disconnect the load from the motor shaft, if possible.
- If any of the drives control terminals are not being used, check whether these unused terminals need to be tied high or low.
- If the motor thermistor terminals are not connected to a motor thermistor, connect these terminals together.
- Check external run contacts are open. Check external speed setpoints are all zero.

Re-apply power to the drive and system

Initial Start-up Routines

Note: Refer to Chapter 5: "Using the Keypad" to familiarise yourself with the keypad's indications, and how to use the keys and menu structure.



IMPORTANT

When power is applied to the drive in Remote Control, it will immediately start running if the RUN signal is active.

WARNING!

Unpredictable motion, especially if motor parameters are incorrect.
 Ensure no personnel are in the vicinity of the motor or any connected machinery.
 Ensure that machinery connected to the motor will not be damaged by unpredictable motion.
 Ensure that the emergency stop circuits function correctly before running the motor for the first time.

The drive can be started in either Remote Control or Local Control. **By default, the drive will start in Local Control.**

These routines assume that the drive's control terminals are wired as shown in the Control Wiring Connections in Chapter 3.

Connected in this way, a positive setpoint will rotate the motor in a clockwise direction when viewed down the shaft, looking toward the motor.

Note: If during the start-up routine the display shows either an alarm (indicated by the letter "A") or a flashing Warning message, refer to Chapter 7: "Trips and Fault Finding".



A typical alarm

Local Control Operation

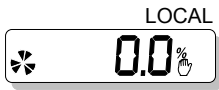

This is the simplest method of operating the drive. Connect the keypad to the drive and power-up the unit. The drive will display the Local screen. If not, refer to Chapter 5 and select Local Control.

Follow the instructions opposite to start and stop the motor.

Reverse: Instead of setting a negative setpoint, you can reverse the motor direction by pressing STOP + ▼, or START + ▼. To change the direction to forwards, (the normal direction), press STOP + ▲ or START + ▲.

Note that the Setpoint parameter will not change sign to indicate this change, however the rotating indicator on the MMI will show the direction.

We recommend that you use the STOP key commands if the motor is stopped, and the START key commands if the motor is running. The keys should be pressed and released together.

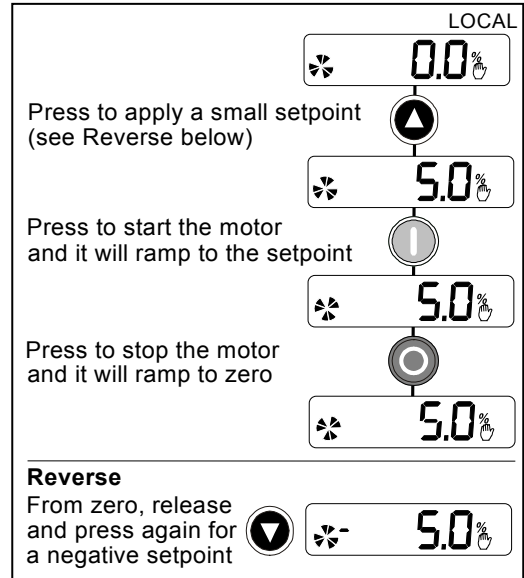

Remote Control Operation

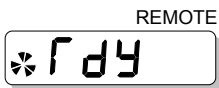

Connect the keypad to the drive and power-up the unit.

The drive will display the Local screen. Refer to Chapter 5 and select Remote Control.

IMPORTANT: Ensure that the speed potentiometer is set to zero.

Follow the instructions below to start and stop the motor using your control panel.

Reverse the motor's direction of rotation using the DIN2 connection (0V = forward, +24V = reverse). Alternatively, swap two of the motor phases (**WARNING: Disconnect the mains supply first**).

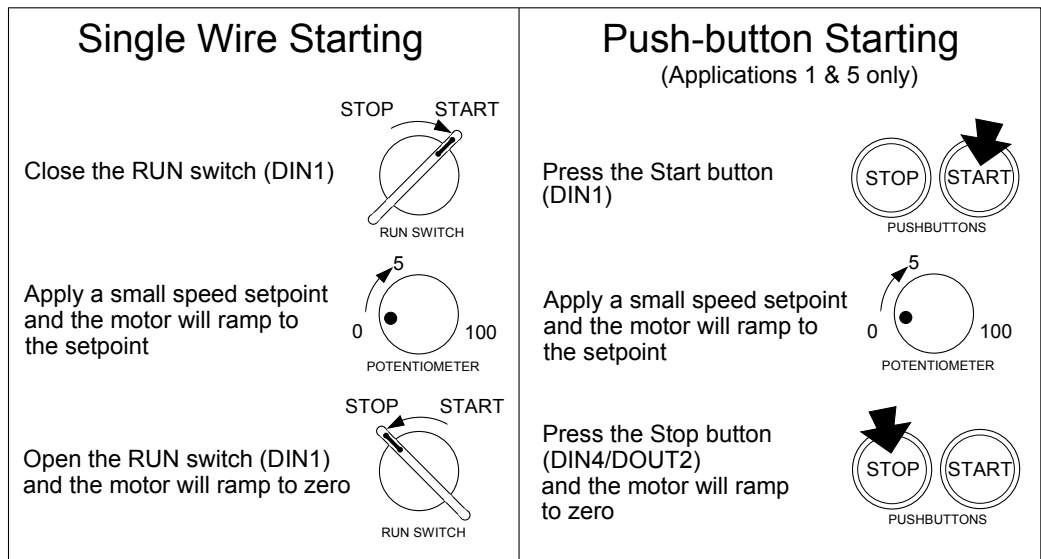

The installation of your drive is now complete:

The drive will operate as an open-loop drive. It is programmed to control an induction motor of equivalent power, current, and voltage rating to the drive. Using the keypad (or other suitable programming tool) the drive must now be set-up:

- as a simple Open-loop drive (V/F Mode)
provides less torque control at low speeds, but is ideal for controlling fans and pumps
- in Sensorless Vector Mode
used for maximum torque control at low speeds, for example, in operating a lift

4-3 Operating the Drive

Set-up as an Open-loop drive (V/F Mode)

The drive will run the motor without any further adjustment. However, the parameters below are pre-loaded with "typical" values that are dependent upon the Product Code for the drive. To improve performance you can enter "actual" values to suit your system; particularly P6 and P7 whose values should be found on the motor nameplate. Now refer to "Tuning the Drive to Your System", page 4-5.

Note: For Product Code dependent defaults, refer to Chapter 6: "Programming Your Application".

Display	Parameter	Default	Brief Description
5CL01	CONTROL MODE	VOLTS / HZ (0)	This parameter contains the main method of motor control used by the drive, and by default is set to VOLTS/HZ
P 6	MOTOR CURRENT	Default is Product Code dependent	Enter the motor nameplate full-load line current
P 7	BASE FREQUENCY	Default is Product Code dependent	Enter the output frequency from the motor nameplate
P 13	FIXED BOOST	Default is Product Code dependent	Enter a boost for starting torque to help with high friction loads

Set-up using the Sensorless Vector Mode

By default, the drive is operating in V/F Mode. Use the keypad to change to Sensorless Vector Mode:

Display	Parameter	Default	Brief Description
5CL01	CONTROL MODE	Set to SENSORLESS VEC (1)	This parameter contains the main method of motor control used by the drive, and by default is set to VOLTS/HZ

To operate in Sensorless Vector Mode, the drive needs to know more about your system. You **MUST** carry out an Autotune (described over the page) but first, enter "actual" values from your motor nameplate for the parameters listed below.

Note: For Product Code dependent defaults, refer to Chapter 6: "Programming Your Application".

Display	Parameter	Default	Brief Description
P 2	MAX SPEED	Default is Product Code dependent	Set the speed in Hz at which the 650V will run when the maximum setpoint is applied
P 6	MOTOR CURRENT	Default is Product Code dependent	Enter the motor nameplate full-load line current
P 7	BASE FREQUENCY	Default is Product Code dependent	Enter the output frequency from the motor nameplate
5CL02	NAMEPLATE RPM	1445.0	Enter the motor nameplate full-load rated speed. This is the motor speed in rpm at base frequency minus full load slip
5CL11	MOTOR POLES	4-pole	Enter the number of motor poles shown on the motor nameplate
5CL12	MOTOR VOLTAGE	Default is Product Code dependent	Enter the motor nameplate voltage at base frequency
5CL14	MAG CURRENT	Default is Product Code dependent	Enter the motor model no-load line current only if performing a Stationary Autotune (see over the page)

Autotuning the Drive

IMPORTANT: You **MUST** carry out an Autotune if you intend to use the drive in Sensorless Vector Mode. If you are using it in Volts/Hz control an Autotune is not necessary.

The Autotune procedure identifies some of the more obscure characteristics about your motor, and automatically loads them into the drive.

Follow the procedure below to complete the Autotune. When the Autotune is finished, refer to "Tuning the Drive to Your System", page 4-5.

1 Stationary or Rotating Autotune?

Will the motor spin freely during the Autotune, i.e. not connected to a load?

- If it can spin freely, use a Rotating Autotune (preferred)
- If it cannot spin freely, use a Stationary Autotune

	Action	Requirements
Rotating Autotune <i>Preferred method</i>	Spins the motor up to the maximum speed set by the user to identify all necessary motor characteristics	Motor must spin freely during Autotune
Stationary Autotune <i>Only used when the motor cannot spin freely during the Autotune feature</i>	Motor does not spin during Autotune. A limited set of motor characteristics are identified	You must enter the correct value of magnetising current Do not subsequently operate the drive above base speed

2 Performing the Autotune

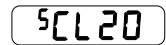
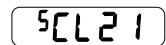
	AUTOTUNE MODE	0	Select the Autotune operating mode
	AUTOTUNE ENABLE	0	Enables the Autotune feature. Refer to "The Autotune Feature" below.

Performing a Rotating Autotune

Check that the motor can rotate freely in the forward direction. Ensure also that the motor is unloaded. Ideally, the motor shaft should be disconnected. If the motor is connected to a gearbox this is ok, provided that there is nothing on the output of the gearbox which could load the motor.

1. Set MAX SPEED (^P 2) to the maximum speed at which you will operate the drive in normal operation. The Autotune will characterise the motor up to 30% above this speed. If you later wish to run faster than this, you will need to carry out another Autotune.
2. Set the AUTOTUNE MODE (^S CL20) parameter to ROTATING (1).
3. Set AUTOTUNE ENABLE (^S CL21) to 1 (TRUE), and start the drive. The drive will carry out a Rotating Autotune, indicated by the Run and Stop led's flashing on the blank cover when fitted, or by flashing **RLN** on the keypad. This may take several minutes, during which the motor will be accelerated to maximum speed and then brought to a stop. When complete, the drive is returned to the stopped condition and the AUTOTUNE ENABLE parameter is reset to 0 (FALSE).

Performing a Stationary Autotune

Before starting the stationary Autotune, you **MUST** enter the value of magnetising current for the motor (^S CL14). This may be available on the motor nameplate. If not, you may need to contact the motor supplier.

1. Set the AUTOTUNE MODE (^S CL20) parameter to STATIONARY (0).
2. Set AUTOTUNE ENABLE (^S CL21) to 1 (TRUE), and start the drive. The drive will carry out a Stationary Autotune, injecting current into the motor but not turning the shaft. The Run and Stop led's will flash on the blank cover when fitted, or **RLN** will flash on the keypad. When complete, the drive is returned to the stopped condition and the AUTOTUNE ENABLE parameter is reset to 0 (FALSE).

4-5 Operating the Drive

Tuning the Drive to Your System

Finally, adjust the parameters below as necessary to tune the drive to your system. Refer to Chapter 6: "Programming Your Application" for details.

Display	Parameter	Default	Brief Description
P 2	MAX SPEED	Default is Product Code dependent	Set the speed in Hz at which the 650V will run when the maximum setpoint is applied. Sensorless Vector Mode: If you change this parameter when in this mode, you must carry out another Autotune.
P 3	MIN SPEED	0.0%	Set the minimum frequency at which the 650V will run, as a % of MAX SPEED
P 4	ACCEL TIME	10.0 s	Set the time taken for the 650V to ramp up from zero to MAX SPEED
P 5	DECEL TIME	10.0 s	Set the time taken for the 650V to ramp down from MAX SPEED to zero
P 8	JOG SETPOINT	10.0 %	Set the jogging speed setpoint, as a % of MAX SPEED
P 9	RUN STOP MODE	0	Select the method by which the motor speed is reduced to zero
P 11	V/F SHAPE	LINEAR	Select LINEAR or FAN flux characteristics (constant or quadratic respectively) when operating in V/F Mode
P 12	HEAVY/NORMAL DUTY	0	Refer to Chapter 6 : P12 for explanation, and consequence of changing P11
P 13	FIXED BOOST	Default is Product Code dependent	Set a boost for starting torque to help with high friction loads

Chapter 5 THE KEYPAD

The 6511 Keypad (Man-Machine Interface, MMI) provides for local control of the drive, monitoring, and complete access for application programming a connection to a pc is required along with the drive software tool.

The 650V can be fitted with either a Standard or Remote Keypad. Both Keypads fit on the front of the drive, but the Remote Keypad (with its extra connector) can also be remote-mounted up to 3 metres away using a connecting lead: refer to Chapter 3: “Installing the Drive” – Fitting the Remote Keypad.

To remove a Keypad, simply pull it away from the drive. To refit it, push it back into place.

The product rating label identifies the Drive/Keypad type: refer to Chapter 9: “Technical Specifications” – Understanding the Product Code.

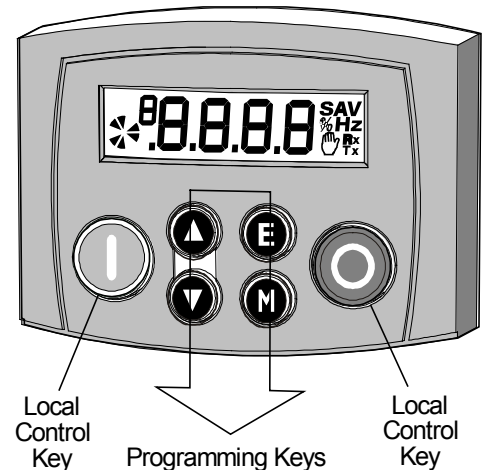

The Power-Up Condition

On initial power-up, direct from the factory, the drive is in Local Control and the MMI will display the Local Setpoint, 0.0 Hz.

All parameters will be at factory default settings. Any changes to these conditions are automatically saved. The drive will initialise on subsequent power-ups with the previously saved settings and control mode, Local or Remote Control.

Controlling the Drive using the Keypad

Control Key Definitions

Key	Operation	Description
	Escape	<i>Navigation</i> – Displays the previous level’s menu <i>Parameter</i> – Returns to the parameter list <i>Trip Display</i> – Removes Trip or Error message from display allowing investigation of parameters
	Menu	<i>Navigation</i> – Displays the next menu level, or the first parameter of the current Menu <i>Parameter</i> – Moves cursor to the left when the parameter is adjustable
	Increment	<i>Navigation</i> – Move upwards through the menu system <i>Parameter</i> – Increase value of the displayed parameter <i>Local Mode</i> – Increase value of the local setpoint
	Decrement	<i>Navigation</i> – Move down through the menu system <i>Parameter</i> – Decrease value of the displayed parameter <i>Local Mode</i> – Decrease value of the local setpoint
	Run	<i>Local Mode</i> – Run the drive <i>Trip Reset</i> – Resets trip condition allowing drive to resume operation
	Stop	<i>Local Mode</i> – Stops the drive. Trip Reset in all modes <i>Navigation</i> – Press and hold to toggle between Local and Remote Control modes (refer to page 5-5) <i>Trip Reset</i> – Resets trip condition allowing drive to resume operation

5-2 The Keypad

Display Indications

P when in the Parameter menu	Displays the units for the value:
S when in the Setup menu	S for time in seconds
A when displaying an Alarm code	A for current in Amperes
- a negative parameter value	V for voltage in Volts
	% for percentage
	Hz for frequency in Hertz

Indicates the Control Mode

Represents a rotating shaft:
clockwise = drive running forward
anticlockwise = drive running in reverse

Indicates communication via fieldbus communication

Indicates parameter numbers or values, trip information, error codes etc. See "Drive Status Indications" below.

Indicates the drive is in Local control mode. Drive is in remote control when Rx Tx is active.

Drive Status Indications

The keypad can display the following status information:



Display	Status Indication and Meaning	Possible Cause
RDY	READY/HEALTHY No alarms present. Remote mode selected	
PASS	PASSWORD Current password must be entered before this parameter may be altered.	Enter password to change the parameter. Refer to page 5-7
LOC	LOCAL Local Control selected, healthy, no alarms present	Added or removed from the display letter-by-letter to indicate entering or leaving Local Control
STOP	STOP Coast Stop or Prog Stop active	Jog (6901 op station only) or Run pressed while Coast Stop or Prog Stop lines are active, (low), on the sequencing block. Local control only.
RUN	RUN Not possible to change between Local/Remote mode	The drive is running in Local mode or the Remote run signal is active
JOG	JOG Not possible to change between Local/Remote mode	The Remote jog signal is active
ENBL	ENABLE Pressed RUN or JOG key in Local mode while Enable signal is low	The drive Enable signal is inactive, (low)

Quick Application Selection

You can navigate immediately to the APPLICATION parameter, ^P1, from power-up, as shown opposite.

Hold down the key opposite:  HOLD
Power-up the drive, continue to hold for at least 1 second

Then, press the  key to display the current Application. Press again to allow the parameter to be changed.

Use the   keys to select the appropriate Application by number.

Press the  key to load the Application.
Refer to Chapter 12: "Applications" for further information.

Selecting the Menu Detail

For ease of operation the drive can display full or reduced menus. Refer to Chapter 6 to see how the setting changes the displayed menu. Additional parameters are indicated with **F** in the table.

Navigate to the **St 99** parameter (SET::SETP::ST99) and press the **M** key. This toggles full or partial menu detail. The default setting of 0 provides partial menu detail. Set the parameter to 1 to enable full menu view.



The DIAGNOSTICS Menu











Display	Name	Description
0.0 Hz	FREQUENCY	The current output frequency in Hertz
0.0%	SPEED SETPOINT	The set point as a percentage of MAX SPEED
0.0 V	DC LINK VOLTS	$V_{ac} (rms) \times \sqrt{2} =$ dc link Volts (when motor stopped)
0.0 A	MOTOR CURRENT	The current load value in Amps



To see the following requires detailed menus view to be enabled, see above “Selecting the Menu Detail”

Display	Name	Description
In	dl n	F INPUTS MENU: DIGIN WORD
	IPR1	F ANIN 1 VALUE
	IPR2	F ANIN 2 VALUE
Out	doUt	F OUTPUTS MENU: DIGOUT WORD
	OPR1	F ANOUT1 VALUE
	OPR2	F ANOUT 2 VALUE
tRIP	tH1	F TRIP HISTORY MENU: TRIP 1 (NEWEST)
	tH2	F TRIP 2
	tH3	F TRIP 3
	tH4	F TRIP 4
	tH5	F TRIP 5
	tH6	F TRIP 6
	tH7	F TRIP 7
	tH8	F TRIP 8
	tH9	F TRIP 9
	tH10	F TRIP 10 (OLDEST)

The Menu System

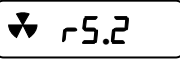
Use the arrow down key  to go left and arrow up key  to go right





 d.A9 Press  to show following:	 PAR Press  to show following:	 SEt See chapter 6 for instructions to view full menu Press  to show following:		 APP This menu is configured by the App Menu blocks in DSE Lite. Also applications 3, 4, 5 & 6 populate this menu as shown. Press  to show following:
Hz Drive frequency % Speed setpoint v DC link volts A Motor current To see the following menu requires detailed menus view to be enabled: To enable arrow to SEt press  arrow to SEt99 and press  key.	P1 Application P2 Max speed P3 Min speed P4 Accel time P5 Decel time P6 Motor current P7 Base frequency P8 Jog setpoint P9 Run/stop mode P11 V/F shape P12 Normal duty P13 Fixed boost P14 Auto boost P99 Password	Ctrl CL01 Control mode CL02 Nameplate RPM CL03 Fly-catch enable CL04 Slip comp enable CL05 Stabilisation enable CL06 Voltage control mode CL07 Boost mode CL08 Auto boost CL09 Energy saving CL10 Motor current CL11 Motor poles CL12 Motor voltage CL14 Mag current CL15 Power CL16 Motor connection CL17 Stator resistance CL18 Leakage inductance CL19 Mutual inductance CL1A Rotor time constant CL20 Autotune mode CL21 Autotune enable CLB1 Current limit CLB2 Positive torque limit CLB3 Negative torque limit CLB4 Stall trip type CL91 Speed prop gain CL92 Speed integral time CL93 Speed positive limit CL94 Speed negative limit	CONF dn1 Digin 1 destination dn2 Digin 2 destination dn3 Digin 3 destination dn4 Digin 4 destination dn5 Digin 5 destination dn6 Digin 6 destination dn7 Digin 7 destination dOP1 Digout 1 source dOP2 Digout 2 source dOP3 Relay source AOP1 Anout 1 source AOP2 Anout 2 source trIP LOOP 4 to 20mA loop t3 Anin 2 overload SEtLL Motor stalled Ot Moter overtemp it Inverse time dbr Dynamic brake resistor db5 Dynamic brake switch SPd Speed feedback OSPd Over speed di5P Display / keypad dCRP DC link ripple	AP1 APP menu 1 AP2 APP menu 2 AP3 APP menu 3 AP4 APP menu 4 AP5 APP menu 5 AP6 APP menu 6 AP7 APP menu 7 AP8 APP menu 8 AP9 APP menu 9 AP10 APP menu 10 AP11 APP menu 11 AP12 APP menu 12 AP13 APP menu 13 AP14 APP menu 14 AP15 APP menu 15 AP16 APP menu 16 Default settings Macro 3: AP1 Preset 0 AP2 Preset 1 AP3 Preset 2 AP4 Preset 3 AP5 Preset 4 AP6 Preset 5 AP7 Preset 6 AP8 Preset 7 Macro 4: AP1 RL ramp rate AP2 RL max value AP3 RL min value AP4 RL reset value Macro 5: AP1 PI P gain AP2 PI I gain AP3 PID D gain AP4 PID D filter TC AP5 PID fbk gain AP6 PID limit AP7 PID low limit AP8 PID symmetric limit AP9 PID scale AP10 PID error AP11 PID output Macro 6: AP1 Command AP2 Setpoint AP3 Status
IN dn Digin word iPA1 Anin 1 value iPA2 Anin 2 value OUT dOUT Digout word OPA1 Anout 1 value OPA2 Anout 2 value trIP tH1 Trip 1, (newest) tH2 Trip 2 tH3 Trip 3 tH4 Trip 4 tH5 Trip 5 tH6 Trip 6 tH7 Trip 7 tH8 Trip 8 tH9 Trip 9 tH10 Trip 10, (oldest)		IN iP01 Digin 1 invert iP02 Digin 2 invert iP03 Digin 3 invert iP04 Digin 4 invert iP05 Digin 5 invert iP06 Digin 6 invert iP07 Digin 7 invert iP11 Anin 1 scale iP12 Anin 1 offset iP13 Anin 1 type iP21 Anin 2 scale iP22 Anin 2 offset iP23 Anin 2 type iPd1 Digin 1 value iPd2 Digin 2 value iPd3 Digin 3 value iPd4 Digin 4 value iPd5 Digin 5 value iPd6 Digin 6 value iPd7 Digin 7 value iPA1 Anin1 value iPA2 Anin2 value	SEtP SEt01 Jog accel time SEt02 Jog decel time SEt03 Ramp time SEt04 S ramp jerk SEt05 S ramp cont SEt06 min speed mode SEt11 Skep freq 1 SEt12 Skip freq 1 band SEt13 Skip freq 2 SEt14 Skip freq 2 band SEt21 AR attempts SEt22 AR delay SEt23 AR triggers SEt24 AR triggers+ SEt31 DB Enable SEt32 DB Resistance SEt33 DB Power SEt34 DB Over-rating SEt41 Torque feedback SEt42 Torque level SEt43 Use abs torque SEt51 Local min speed SEt52 Enabled keys SEt98 Application lock SEt99 Detailed menus	
Software Version Number This is displayed on power-up, for up to 8 seconds. For example, version 5.2:  It can also be displayed by pressing the E key for 2 seconds when at the top of the MMI tree, Menu Level 1.				
		OUT OPd1 Digout 1 invert OPd2 Digout 2 invert OPd3 Relay invert AO11 Anout 1 scale AO12 Anout 1 offset AO13 Anout 1 abs AO14 Anout 1 value AO21 Anout 2 scale AO22 Anout 2 offset AO23 Anout 2 abs AO24 Anout 2 value	EnC En01 Encoder mode En02 Encoder reset En03 Encoder invert En04 Encoder lines En05 Encoder speed scale En06 Encoder speed	

NOTE:
 To move up and down the lists arrow up  to go down and arrow down  to go up.

Special Menu Features

How To Change a Parameter Value



You can change the values of parameters stored in the **PAF** and **SEt** menus. Refer to Chapter 6: “Programming Your Application” – Configurable Parameters for further information.

- View the parameter to be edited and press  to display the parameter’s value.
- Select the digit to be changed (pressing the  key moves the cursor from right to left).
- Use the   keys to adjust the value. Hold the key momentarily to adjust the value marginally, or hold the key to make rapid changes; the rate of change varies with the time held.
- Press  to return to the parameter display. The new value is stored.

Resetting to Factory Defaults (2-button reset)

Power-up the drive whilst holding the keys as shown to return to factory default settings.



This loads Application 1. Then press the  key.



Hold down the keys opposite:   *HOLD*
Power-up the drive, continue to hold for at least 1 second

Changing the Default Operating Frequency

Power-up the drive whilst holding the keys as shown to display the Engineers Menu.

IMPORTANT: This menu contains sensitive parameters that can dramatically alter the running of the drive.

Hold down the keys opposite:   *hold*
Power-up the drive, continue to hold for at least 1 second

This displays parameter $E0.01$. Press the  key to navigate to $E0.02$. Press the  key to edit the parameter: 0 = 50Hz (default), 1 = 60Hz. Select the required frequency then press the  key.

Power-down the drive. No change has been made to the active configuration at this point. To save the change to parameter $E0.02$, you must now perform a 2-button reset (as above). Please note that this will return the drive to its factory default settings for the selected default frequency.

5-6 The Keypad

Selecting Local or Remote Control

The drive can operate in one of two ways:

- Remote Control:** Allowing access for application programming using digital and analog inputs and outputs
- Local Control:** Providing local control and monitoring of the drive using the Keypad

Local control keys are inactive when Remote Control is selected.

In Remote Control, the drive uses a remote setpoint. In Local Control, it uses the Local Setpoint parameter whose value is adjusted on the MMI.

Note: You can only change between Local and Remote Control when the drive is "stopped", and either **r dY** or the Local Setpoint is displayed.

Remote to Local Control:

Hold this key down until the display shows **r dY**

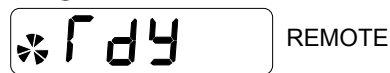

Hold this key down until the display spells **L O C**



Release the key to display the Local Setpoint



Local to Remote Control:

View the Local Setpoint



Hold this key down until **L O C** is removed from the display



Release the key to display **r dY**



Note: For safety reasons, the drive will not return to Remote Control if this will cause the drive to start. Check RUN and JOG inputs are low.

Changing Direction in Local Control

When the drive is running in Local Control the direction of rotation of the motor shaft can be changed by pressing the following key combinations:

To change the direction to Forward, press UP and START or UP and STOP.

To change the direction to Reverse, press DOWN and START or DOWN and STOP.

It is recommended that if the motor is already turning, choose the key combination that includes the START key. If the motor is stopped then choose the key combination that includes the STOP key.

Password Protection

When activated, an odd-numbered password prevents unauthorised parameter modification by making all parameters read-only. The local setpoint is not made read-only if an even-numbered password is used. Password protection is set-up using the **P 99** parameter

Steps	ACTIVATE		TEMPORARY DE-ACTIVATION		REMOVE PASSWORD	
	Actions	Display	Actions	Display	Actions	Display
1	Go to P 99 Press M	0000	Try to edit any parameter with password activated	PASS → 0000	Go to P 99 Press M	PASS → 0000
2	Enter new password using ▲ ▼ for example	000 1	Enter current password using ▲ ▼ for example	000 1	Enter current password using ▲ ▼ for example	000 1
3	Press E repeatedly until top of menu is reached	r d y , Remote Setpoint or Local Setpoint	Press E	Original parameter displayed, password de-activated	Press E Reset to 0000 using ▲ ▼	0000
4	Press E to activate password	r d y , Remote Setpoint or Local Setpoint	<i>A drive will power-up with the last password status. Temporary de-activation is lost on power-down.</i>		Press E to remove password	P 99
	<i>Default = 0000, de-activated Any other value is a password</i>					

Chapter 6 PROGRAMMING YOUR APPLICATION

You can program the drive to your specific application. This programming simply involves changing parameter values. For instance, parameter ^P1 selects various Applications which can be used as starting points for application-specific programming.

Each Application internally re-wires the drive for a different use when it is loaded. The default for the parameter is "1". Changing this parameter's setting to "2" will load Application 2. Refer to Chapter 12: "Applications" for further information.

If necessary, there are three parameters for tuning your drive. Refer to PID - Tuning Your Drive, page 6-14.

Saving Your Modifications

When parameter values are modified or an Application is loaded, the new settings are saved automatically. The drive will retain the new settings during power-down.

MMI Parameters

This table provides information about each parameter accessible using the keypad, or MMI (Man Machine Interface). For more information about these and additional parameters accessible using DSE Lite (or other suitable programming tool), refer to the 650V Software Product Manual on our website: www.parker.com/ssd.

Key to MMI Parameters Table

F	Parameters indicated with F are visible with full menus only. Refer to the DETAILED MENUS parameter (ST 99).
M	Parameters indicated with M are Motor Parameters. They are not reset by changing Application using parameter ^P 1; all other parameters are reset to default values.
VF	Parameters indicated with VF are only visible when the drive is in VF (Volts/Hz) motor control mode, as selected by parameter ^S CL01.
SV	Parameters indicated with SV are only visible when the drive is in SV (Sensorless Vector) motor control mode, as selected by parameter ^S CL01.

Note: The "Range" for a parameter value is given in the Configurable Parameters Table. Ranges for outputs are given as "—.xx %", for example, indicating an indeterminate integer for the value, to two decimal places.

MMI Parameters Table

MMI Parameters Table				
Display	Parameter	Description	Range	Default
SET::PAR Menu				
P	APPLICATION	<p>This parameter selects and loads the Application to be used. APP 0 will not control a motor. APP 6, 7 & 8 are for future use. You can edit an Application in DSE Lite and, then set this parameter to CUSTOM to produce your own custom Application.</p> <p>Refer to the 650V Software Product Manual, Chapter 5: "Applications" which gives detailed information about each Application.</p> <p>Note: Parameter values are changed to factory settings by loading a new Application, except Motor Parameters (indicated M)</p>	0= NULL 1= STANDARD 2= LOCAL/REM (AUTO/MANUAL) 3= PRESETS 4= RAISE/LOWER 5= PID 6= AUXILIARY COMMS 7= APP 7 8= APP 8 9= CUSTOM	1

MMI Parameters Table				
Display	Parameter	Description	Range	Default
P 2	MAX SPEED M	The frequency at which the 650V will run when maximum setpoint is applied. The default is Product Code dependent	7.5 to 300Hz	50 or 60Hz
P 3	MIN SPEED	The minimum frequency at which the 650V will run, as a percentage of the MAX SPEED parameter	-100.0 to 100.0%	0.0%
P 4	ACCEL TIME	The time taken for the 650V output frequency to ramp up from zero to MAX SPEED	0.0 to 3000.0s	10.0s
P 5	DECEL TIME	The time taken for the 650V output frequency to ramp down from MAX SPEED to zero	0.0 to 3000.0s	10.0s
P 6	MOTOR CURRENT M	This parameter contains the motor nameplate full-load line current	0.01 to 999.99A	product code dependent
P 7	BASE FREQUENCY M	The output frequency at which maximum voltage is reached. The default is Product Code dependent	7.5 to 240Hz	50 or 60Hz
P 8	JOG SETPOINT	Speed the 650V will run at if the Jog input is high, as a percentage of the MAX SPEED parameter	-100.0 to 100.0%	10.0%
P 9	RUN STOP MODE	RAMPED : The motor speed is reduced to zero at a rate set by DECEL TIME (P5). A 2 second DC pulse is applied at end of ramp COAST : The motor is allowed to freewheel to a standstill DC INJECTION : On a stop command, the motor volts are rapidly reduced at constant frequency to deflux the motor. A low frequency braking current is then applied until the motor speed is almost zero. This is followed by a timed DC pulse to hold the motor shaft.	0=RAMPED 1=COAST 2=DC INJECTION	0
P 11	V/F SHAPE	LINEAR LAW: This gives a constant flux characteristic up to the BASE FREQUENCY FAN LAW: This gives a quadratic flux characteristic up to the BASE FREQUENCY. This matches the load requirement for fan and most pump applications Refer to P12	0=LINEAR LAW 1=FAN LAW	0

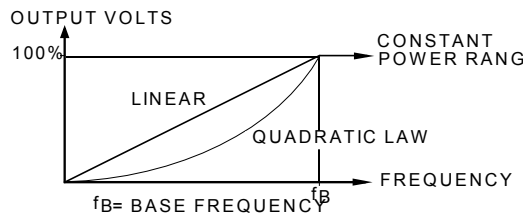

6-3 Programming Your Application

MMI Parameters Table

Display	Parameter	Description	Range	Default
P 12	NORMAL DUTY	<p>% OF RATED MOTOR CURRENT</p> <p>150% 127.5% 105% 100%</p> <p>30 60</p> <p>TIME (s)</p> <p>100% overload for 30s (Heavy Duty)</p> <p>FALSE - HEAVY DUTY: Inverse time allows 150% overload for 30s, then ramps back the current limit to 105% over a 10s period. At a lower load, the overload area remains the same, e.g. at 127.5% load for 60s - after 60s has expired, the output of the inverse time function is ramped back over a 10s period from 150% as before.</p> <p>TRUE - NORMAL DUTY: current limit is set to 110% motor current, inverse time delay is set to 30s</p> <p>When P11 is changed from FAN LAW to LINEAR LAW, P12 is set to 0 (HEAVY DUTY)</p> <p>When P11 is changed from LINEAR LAW to FAN LAW, P12 is set to 1 (NORMAL DUTY)</p> <p>P12 can be changed independently</p>	0=FALSE 1=TRUE	0
P 13	FIXED BOOST MVF	<p>Used to correctly flux the motor at low speeds. This allows the drive to produce greater starting torque for high friction loads. It increases the motor volts above the selected V/F characteristic at the lower end of the speed range</p> <p>OUTPUT VOLTS</p> <p>100% 25% 0%</p> <p>INCREASED TORQUE FLUXING</p> <p>NORMAL FLUXING</p> <p>INCREASING BOOST</p> <p>f_B = BASE FREQUENCY</p> <p>CONSTANT POWER RANGE</p> <p>FREQUENCY</p>	0.00 to 25.00%	product code dependent
P 14	AUTO BOOST MVF	<p>This parameter allows for load dependent, stator resistance voltage-drop compensation. This correctly fluxes the motor (under load conditions) at low output frequencies, thereby increasing available motor torque. AUTO BOOST is only used when BOOST MODE is set to 0.</p> <p>The value of the AUTO BOOST parameter determines the level of additional volts supplied to the motor for 100% load.</p> <p>Setting the value of AUTO BOOST too high can cause the drive to enter current limit. If this occurs, the time taken for the drive to reach operating speed will be extended. Reducing the value of AUTO BOOST will eliminate this problem.</p>	0.00 to 25.00%	0.00 %
P 99	PASSWORD	<p>A password may be set to prohibit unauthorised adjustment of parameters. When P99 is set to non-zero you will be required to match this value before parameters can be adjusted</p>	0000 – FFFF	0000

NORMAL DUTY was previously referred to as Quadratic Torque in past Drives' manuals.

MMI Parameters Table				
Display	Parameter	Description	Range	Default
SET::CTRL Menu				
5CL01	CONTROL MODE	This parameter contains the main method of motor control used by the drive	0=VOLTS/HZ 1=SENSORLESS VEC	0
5CL02	NAMEPLATE RPM M	This parameter contains the motor nameplate full-load rated speed. This is the motor speed in rpm at base frequency minus full load slip	0.1 to 30000.0 RPM	product code dependent
5CL03	FLY-CATCH ENABLE VF	Enables flycatching in Volts/Hz control mode when TRUE. Allows the drive to catch a spinning load.	0=FALSE 1=TRUE	0
5CL03	FLY-CATCH ENABLE SV	Enables flycatching in Sensorless Vector control mode when TRUE. Allows the drive to catch a spinning load.	0=FALSE 1=TRUE	0
5CL04	SLIP COMP ENABLE VF	Slip compensation is operational when TRUE. Eliminates motor speed variations under load conditions in V/F Fluxing Mode when the correct value for MAG CURRENT is entered into ⁵ CL14	0=FALSE 1=TRUE	0
5CL05	STABILISATION ENABLE VF	Enables the stabilisation function when TRUE. Eliminates light load speed variations in V/F Fluxing Mode	0=FALSE 1=TRUE	1
5CL06	VOLTAGE CONTROL MODE VF	NONE : no attempt is made to control the PWM modulation depth for variations in dc link voltage FIXED : the drive's output volts are maintained, regardless of variations in the dc link voltage. The drive's product code sets the default value for demanded maximum output voltage (see MOTOR VOLTAGE below) AUTOMATIC : the drive performs controlled over-fluxing during motor deceleration	0=NONE 1=FIXED 2=AUTOMATIC	0
5CL07	BOOST MODE FVF	Determines the relationship between fixed boost and terminal volts. There are two settings: FALSE produces the terminal volts profile shown below (with Auto Boost set to 0.0 %). In this mode AUTO BOOST (CL08) should also be set to provide optimum low speed performance. TRUE emulates the terminal volts profile provided by the Parker SSD Drives' 601 product. This allows drop in replacement of the 601 by the 650V. AUTO BOOST (CL08) has no effect in this mode.	0=FALSE 1=TRUE	1

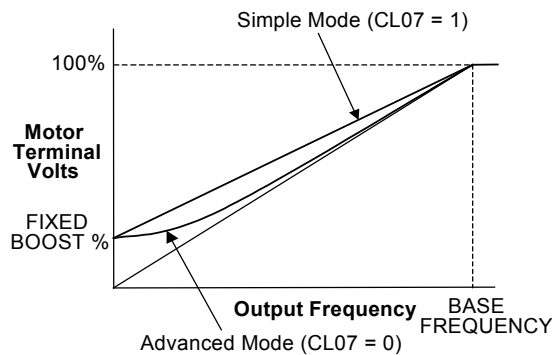

6-5 Programming Your Application

MMI Parameters Table				
Display	Parameter	Description	Range	Default
5CL08	AUTO BOOST FMVF	This parameter allows for load dependent, stator resistance voltage-drop compensation. This correctly fluxes the motor (under load conditions) at low output frequencies, thereby increasing available motor torque. AUTO BOOST is only used when BOOST MODE is set to 0. The value of the AUTO BOOST parameter determines the level of additional volts supplied to the motor for 100% load. Setting the value of AUTO BOOST too high can cause the drive to enter current limit. If this occurs, the time taken for the drive to reach operating speed will be extended. Reducing the value of AUTO BOOST will eliminate this problem.	0.00 to 25.00 %	0.00 %
5CL09	ENERGY SAVING FVF	When set TRUE, the demanded volts are reduced to minimise energy consumption if the drive is operating in a steady state at light load.	0=FALSE 1=TRUE	0
5CL10	MOTOR CURRENT MSV	This parameter contains the motor nameplate full-load line current	0.01 to 999.99A	product code dependent
5CL11	MOTOR POLES MSV	This parameter contains the number of motor poles, as supplied on the motor nameplate	2=2 pole 4=4 pole 6=6 pole 8=8 pole 10=10 pole 12=12 pole	4
5CL12	MOTOR VOLTAGE M	This parameter contains the motor nameplate voltage at base frequency	0.0 to 575.0V	product code dependent
5CL14	MAG CURRENT M	This parameter contains the motor model no-load line current as determined by the Autotune, or taken from the motor nameplate	0.01 to 999.99 A	product code dependent
5CL15	POWER MSV	This parameter contains the motor nameplate power.	0.00 to 355.00kW	product code dependent
5CL16	MOTOR CONNECTION MSV	This parameter contains the motor nameplate connection.	0= DELTA 1= STAR	1
5CL17	STATOR RES FMSV	This parameter contains the motor model per-phase stator resistance as determined by Autotune.	0.0000 to 250.0000Ω	product code dependent
5CL18	LEAKAGE INDUC FMSV	This parameter contains the motor model per-phase leakage inductance as determined by Autotune.	0.00 to 300.00mH	product code dependent
5CL19	MUTUAL INDUC FMSV	This parameter contains the motor model per-phase mutual inductance as determined by Autotune.	0.00 to 3000.00mH	product code dependent
5CL1A	ROTOR TIME CONST FMSV	This parameter contains the motor model rotor time constant as determined by Autotune.	10.00 to 3000.00ms	product code dependent
5CL20	AUTOTUNE MODE SV	Selects the Autotune operating mode.	0= STATIONARY 1= ROTATING	0
5CL21	AUTOTUNE ENABLE SV	Determines whether the Autotune sequence is operational or not. The Autotune sequence is operational when set to TRUE and the drive is run	0=FALSE 1=TRUE	0
5CLB1	CURRENT LIMIT F	This parameter sets the level of motor current, as a % of MOTOR CURRENT (5CL10) at which the drive begins to take current limit action.	0.00 to 300.00%	300.00%
5CLB2	POS TORQUE LIMIT F	This parameter sets the maximum allowed level of positive motor torque.	-500.0 to 500.0%	200.0%

MMI Parameters Table				
Display	Parameter	Description	Range	Default
5CL83	NEG TORQUE LIMIT F	This parameter sets the maximum allowed level of negative motor torque.	-500.0 to 500.0%	-200.0%
5CL84	STALL TRIP TYPE F	This parameter determines whether the stall trip operates on motor torque or motor current. FALSE = TORQUE, TRUE = CURRENT	0= FALSE 1= TRUE	1
5CL91	SPEED PROP GAIN FMSV	Sets the proportional gain of the loop. Speed error (revolutions per second) x proportional gain = torque percent.	0.00 to 300.00	product code dependent
5CL92	SPEED INT TIME FMSV	This is the integral time constant of the speed loop. A speed error which causes the proportional term to produce a torque demand T, will cause the integral term to also ramp up to a torque demand T after a time equal to "speed int time".	1 to 15000ms	product code dependent
5CL93	SPEED POS LIMIT FVS	This sets the upper limit of the speed demand.	-110.00 to 110.00%	110.00%
5CL94	SPEED NEG LIMIT FVS	This sets the lower limit of the speed demand.	-110.00 to 110.00%	-110.00%

6-7 Programming Your Application

MMI Parameters Table				
Display	Parameter	Description	Range	Default
SET::IN Menu				
5 IP01	DIN 1 INVERT	Inverts the value of the signal, TRUE or FALSE.	0 = FALSE 1 = TRUE	0
5 IP02	DIN 2 INVERT	As ^S IP01	As ^S IP01	0
5 IP03	DIN 3 INVERT	As ^S IP01	As ^S IP01	0
5 IP04	DIN 4 INVERT	As ^S IP01	As ^S IP01	0
5 IP05	DIN 5 INVERT	As ^S IP01	As ^S IP01	1
5 IP06	DIN 6 INVERT	As ^S IP01	As ^S IP01	0
5 IP07	DIN 7 INVERT	As ^S IP01	As ^S IP01	0
5 IP11	AIN 1 SCALE	TYPE SCALE OFFSET	-300.0 to 300.0%	100.0%
5 IP12	AIN 1 OFFSET	UNPROCESSED INPUT	-300.0 to 300.0%	0.0%
5 IP13	AIN 1 TYPE	0 to 100% of selected TYPE	0 = 0-10V 1 = 0-5V	0
5 IP21	AIN 2 SCALE	TYPE SCALE OFFSET	-300.0 to 300.0%	100.0%
5 IP22	AIN 2 OFFSET	UNPROCESSED INPUT	-300.0 to 300.0%	0.0%
5 IP23	AIN 2 TYPE	0 to 100% of selected TYPE	0 = 0-10V 1 = 0-5V 2 = 0-20mA 3 = 4-20mA	3
5 IPd1	DIN 1 VALUE	The TRUE or FALSE input (after any inversion)	0=FALSE 1=TRUE	0
5 IPd2	DIN 2 VALUE	The TRUE or FALSE input (after any inversion)	0=FALSE 1=TRUE	0
5 IPd3	DIN 3 VALUE	The TRUE or FALSE input (after any inversion)	0=FALSE 1=TRUE	0
5 IPd4	DIN 4 VALUE	The TRUE or FALSE input (after any inversion)	0=FALSE 1=TRUE	0
5 IPd5	DIN 5 VALUE	The TRUE or FALSE input (after any inversion)	0=FALSE 1=TRUE	0
5 IPd6	DIN 6 VALUE	The TRUE or FALSE input (after any inversion)	0=FALSE 1=TRUE	0
5 IPd7	DIN 7 VALUE	The TRUE or FALSE input (after any inversion)	0=FALSE 1=TRUE	0
5 IPA1	AIN 1 VALUE	The input reading with scaling and offset applied	— .x%	— .x%
5 IPA2	AIN 2 VALUE	The input reading with scaling and offset applied	— .x%	— .x%

MMI Parameters Table				
Display	Parameter	Description	Range	Default
SET::OUT Menu				
d1	DIGOUT1 INVERT	(OUTPUT) As IP01 .	As IP01	0
d2	DIGOUT2 INVERT	(OUTPUT) As IP01 .	As IP01	0
d3	RELAY INVERT	(OUTPUT) As IP01 .	As IP01	0
A011	ANOUT1 SCALE		-300.00 to 300.00%	100.00%
A012	ANOUT1 OFFSET		-300.00 to 300.00%	0.00%
A013	ANOUT1 ABS		0= FALSE (not absolute) 1= TRUE (absolute)	1
A014	ANOUT1 VALUE		-300.00 to 300.00%	0%
A021	ANOUT2 SCALE		-300.00 to 300.00%	100.00%
A022	ANOUT2 OFFSET		-300.00 to 300.00%	0.00%
A023	ANOUT2 ABS		0=FALSE 1=TRUE	0
A024	ANOUT2 VALUE		-300.0 to 300.0%	0.0%

SET::CONF Menu				
Defaults for this sub-menu are determined by the selected application				
d1n1	DIGIN 1 DEST		0:NONE 1:RUN FORWARD 2:RUN REVERSE 3:NOT STOP 4:JOG 5:CONTACTOR CLOSED 6:DRIVE ENABLE 7:NOT FAST STOP 8:NOT COAST STOP 9:REMOTE REVERSE 10:REM TRIP RESET 11:RAISE INPUT 12:LOWER INPUT 13:RL RESET 14:PID ENABLE	15:VALUE 1 INPUT A 16:VALUE 1 INPUT B 17:VALUE 1 INPUT C 18:VALUE 2 INPUT A 19:VALUE 2 INPUT B 20:VALUE 2 INPUT C 21:VALUE 3 INPUT C 22:VALUE 4 INPUT C 23:LOGIC 1 INPUT A 24:LOGIC 1 INPUT B 25:LOGIC 1 INPUT C 26:LOGIC 3 INPUT A 27:LOGIC 3 INPUT B 28:LOGIC 3 INPUT C
d1n2	DIGIN 2 DEST			
d1n3	DIGIN 3 DEST			
d1n4	DIGIN 4 DEST			
d1n5	DIGIN 5 DEST			
d1n6	DIGIN 6 DEST			
d1n7	DIGIN 7 DEST			
dOP1	DIGOUT 1 SOURCE		0= NONE 1= HEALTH 2= TRIPPED 3= RUNNING 4= AT ZERO 5= AT SPEED 6= AT LOAD 7= READY	0= NONE 1= HEALTH 2= TRIPPED 3= RUNNING 4= AT ZERO 5= AT SPEED 6= AT LOAD 7= READY
dOP2	DIGOUT 2 SOURCE			
dOP3	RELAY SOURCE			
AOP1	ANOUT 1 SOURCE			
AOP2	ANOUT 2 SOURCE		0= NONE 1= DEMAND 2= CURRENT 3= PID ERROR 4= RAISE/LOWER OUTPUT	0= NONE 1= DEMAND 2= CURRENT 3= PID ERROR 4= RAISE/LOWER OUTPUT
AOP2	ANOUT 2 SOURCE			





6-9 Programming Your Application

MMI Parameters Table				
Display	Parameter	Description	Range	Default
SET::TRIP Menu				
5LOOP	DISABLE LOOP	Disables LOST I LOOP trip (4-20mA)	0= TRIP ENABLED 1= TRIP DISABLED	1
5t3	AIN2 OVERLOAD	Disables the overload trip (Terminal 3)	As 5LOOP	0
5tLL	DISABLE STALL	Disables STALL trip	As 5LOOP	0
5Ot	DISABLE MOTOR OVERTEMP	Disables the motor thermistor trip	As 5LOOP	0
5It	INVERSE TIME	Disables the inverse time trip	As 5LOOP	1
5db r	DYNAMIC BRAKE RESISTOR	Disables the dynamic brake resistor trip	As 5LOOP	1
5db S	DYNAMIC BRAKE SWITCH	Disables the dynamic brake switch trip	As 5LOOP	1
5SPd	SPEED FEEDBACK	Disables the speed feedback trip	As 5LOOP	0
5OSPd	OVERSPEED	Disables the overspeed trip	As 5LOOP	0
5di SP	DISPLAY (KEYPAD)	Disables the display (keypad) trip	As 5LOOP	0
5dLPP	DC LINK RIPPLE	Disables the DC link ripple trip	As 5LOOP	0
SET::SERL Menu				
5SE01	REMOTE COMMS SEL	Selects the type of remote communications mode: 0 : FALSE, and in REMOTE mode then control is from the terminals. 1 : TRUE, and in REMOTE mode then control is from the communications.	0=FALSE 1=TRUE	0
5SE02	COMMS TIMEOUT	Sets the maximum time allowed between refreshing the COMMS COMMAND parameter. The drive will trip if this time is exceeded. Set the time to 0.00 seconds to disable this feature.	0.0 to 600.0s	0.0s
5SE03	COMMS ADDRESS	The drives identity address. Note: if set to 0, it will only respond to broadcast messages.	0 to 255	0
5SE04	BAUD RATE	Selects the Baud Rate for the MODBUS protocol.	0 : 1200 1 : 2400 2 : 4800 3 : 7200 4 : 9600 5 : 14400 6 : 19200 7 : 38400 8 : 57600	4
5SE05	PARITY	Selects the Parity for the MODBUS protocol.	0= NONE 1= ODD 2= EVEN	0
5SE06	REPLY DELAY ms	The time in milliseconds between the drive receiving the complete request from the communications master (PLC/PC) and replying to this request.	0 to 200	5
5SE07	OP PORT PROTOCOL	Selects the protocol to be used by the keypad port on the front of the drive. When EIBISYNC ASCII is selected, BAUD RATE is 19200 and PARITY is EVEN. FIELDBUS is reserved for future use.	0= AUTOMATIC 1= KEYPAD 2=EIBISYNC ASCII 3= MODBUS 4= FIELDBUS	0
5SE08	P3 PORT PROTOCOL	Selects the protocol to be used by the RS232 programming port on the drive's control board. When EIBISYNC ASCII is selected, BAUD RATE is 19200 and PARITY is EVEN. FIELDBUS is reserved for future use.	As 5SE07	0

MMI Parameters Table				
Display	Parameter	Description	Range	Default
SET::SETP Menu				
55E01	JOG ACCEL TIME	As ^P 4, for Jog	0.0 to 3000.0s	1.0
55E02	JOG DECEL TIME	As ^P 5, for Jog	0.0 to 3000.0s	1.0
55E03	RAMP TYPE	Selects the ramp type	0=LINEAR 1=S	0
55E04	S RAMP JERK	Rate of change of acceleration of the curve in units per second ³	0.01 to 100.00 s ³	10.00
55E05	S RAMP CONTINUOUS	When TRUE and the S ramp is selected, forces a smooth transition if the speed setpoint is changed when ramping. The curve is controlled by the S RAMP JERK parameter. When FALSE, there is an immediate transition from the old curve to the new curve	0=FALSE 1=TRUE	1
55E06	MIN SPEED MODE	Selects a mode to determine how the drive will follow a reference: Proportional : minimum limit, Linear : between minimum and maximum.	0=PROP.W/MIN. 1=LINEAR (used by the 601 product)	0
55E11	SKIP FREQUENCY 1	This parameter contains the centre frequency of skip band 1 in Hz	0.0 to 240.0 Hz	0.0
55E12	SKIP FREQUENCY BAND 1	The width of skip band 1 in Hz	0.0 to 60.0 Hz	0.0
55E13	SKIP FREQUENCY 2	This parameter contains the centre frequency of skip band 2 in Hz	0.0 to 240.0 Hz	0.0
55E14	SKIP FREQUENCY BAND 2	The width of skip band 2 in Hz	0.0 to 60.0 Hz	0.0
55E21	AUTO RESTART ATTEMPTS	Determines the number of restarts that will be permitted before requiring an external fault reset	0 to 10	0
55E22	AUTO RESTART DELAY	Determines the delay between restart attempts for a trip included in AUTO RESTART TRIGGERS and AUTO RESTART TRIGGERS+. The delay is measured from all error conditions clearing	0.0 to 600.0 s	10.0
55E23	AUTO RESTART TRIGGERS	Allows Auto Restart to be enabled for a selection of trip conditions. Refer to Chapter 6: "Trips and Fault Finding" - Hexadecimal Representation of Trips	0x0000 to 0xFFFF	0x0000
55E24	AUTO RESTART TRIGGERS+	Allows Auto Restart to be enabled for a selection of trip conditions. Refer to Chapter 6: "Trips and Fault Finding" - Hexadecimal Representation of Trips	0x0000 to 0xFFFF	0x0000
55E31	DB ENABLE	Enables operation of the dynamic braking.	0=FALSE 1=TRUE	1
55E32	DB RESISTANCE	The value of the load resistance.	1 to 1000	product code dependent
55E33	DB POWER	The power that the load resistance may continually dissipate.	0.1 to 510.0 kW	product code dependent
55E34	DB OVER-RATING	Multiplier that may be applied to DB POWER for power overloads lasting no more than 1 second.	1 to 40	25
55E41	TORQUE FEEDBACK	Shows the estimated motor torque, as a percentage of rated motor torque.	— .xx %	— .xx %
55E42	TORQUE LEVEL	This parameter sets the value of load at which AT LOAD becomes TRUE. AT LOAD may be connected to a digital output. Refer to ^S DOP1 and ^S DOP3. 100% = rated torque for the motor.	-300.0 to 300.0 %	100.0 %

6-11 Programming Your Application

MMI Parameters Table

Display	Parameter	Description	Range	Default																																																																																					
55t43	USE ABS TORQUE F	When TRUE, the direction of rotation is ignored. In this case, the comparison level should always be positive. When FALSE, the direction of rotation is not ignored. Driving a load in the reverse direction gives a negative value for torque. In this case, the comparison level may be positive or negative.	0=FALSE 1=TRUE	0																																																																																					
55t51	LOCAL MIN SPEED F	The magnitude of the minimum setpoint that will be used when running in Local Mode.	0.0 to 100.0 %	0.0 %																																																																																					
55t52	ENABLED KEYS F	The following keys on the 6901 keypad can be enabled or disabled separately. The combination produces the parameter setting as in the table below. The default of FFFF enables all keys.	0000 to FFFF	FFFF																																																																																					
 6901		<table border="1"> <thead> <tr> <th>Parameter Setting</th> <th>RUN</th> <th>L/R</th> <th>JOG</th> <th>DIR</th> </tr> </thead> <tbody> <tr><td>0000</td><td>-</td><td>-</td><td>-</td><td>-</td></tr> <tr><td>0010</td><td>-</td><td>-</td><td>-</td><td>ENABLED</td></tr> <tr><td>0020</td><td>-</td><td>-</td><td>ENABLED</td><td>-</td></tr> <tr><td>0030</td><td>-</td><td>-</td><td>ENABLED</td><td>ENABLED</td></tr> <tr><td>0040</td><td>-</td><td>ENABLED</td><td>-</td><td>-</td></tr> <tr><td>0050</td><td>-</td><td>ENABLED</td><td>-</td><td>ENABLED</td></tr> <tr><td>0060</td><td>-</td><td>ENABLED</td><td>ENABLED</td><td>-</td></tr> <tr><td>0070</td><td>-</td><td>ENABLED</td><td>ENABLED</td><td>ENABLED</td></tr> <tr><td>0080</td><td>ENABLED</td><td>-</td><td>-</td><td>-</td></tr> <tr><td>0090</td><td>ENABLED</td><td>-</td><td>-</td><td>ENABLED</td></tr> <tr><td>00A0</td><td>ENABLED</td><td>-</td><td>ENABLED</td><td>-</td></tr> <tr><td>00B0</td><td>ENABLED</td><td>-</td><td>ENABLED</td><td>ENABLED</td></tr> <tr><td>00C0</td><td>ENABLED</td><td>ENABLED</td><td>-</td><td>-</td></tr> <tr><td>00D0</td><td>ENABLED</td><td>ENABLED</td><td>-</td><td>ENABLED</td></tr> <tr><td>00E0</td><td>ENABLED</td><td>ENABLED</td><td>ENABLED</td><td>-</td></tr> <tr><td>00F0</td><td>ENABLED</td><td>ENABLED</td><td>ENABLED</td><td>ENABLED</td></tr> </tbody> </table>	Parameter Setting	RUN	L/R	JOG	DIR	0000	-	-	-	-	0010	-	-	-	ENABLED	0020	-	-	ENABLED	-	0030	-	-	ENABLED	ENABLED	0040	-	ENABLED	-	-	0050	-	ENABLED	-	ENABLED	0060	-	ENABLED	ENABLED	-	0070	-	ENABLED	ENABLED	ENABLED	0080	ENABLED	-	-	-	0090	ENABLED	-	-	ENABLED	00A0	ENABLED	-	ENABLED	-	00B0	ENABLED	-	ENABLED	ENABLED	00C0	ENABLED	ENABLED	-	-	00D0	ENABLED	ENABLED	-	ENABLED	00E0	ENABLED	ENABLED	ENABLED	-	00F0	ENABLED	ENABLED	ENABLED	ENABLED		
Parameter Setting	RUN	L/R	JOG	DIR																																																																																					
0000	-	-	-	-																																																																																					
0010	-	-	-	ENABLED																																																																																					
0020	-	-	ENABLED	-																																																																																					
0030	-	-	ENABLED	ENABLED																																																																																					
0040	-	ENABLED	-	-																																																																																					
0050	-	ENABLED	-	ENABLED																																																																																					
0060	-	ENABLED	ENABLED	-																																																																																					
0070	-	ENABLED	ENABLED	ENABLED																																																																																					
0080	ENABLED	-	-	-																																																																																					
0090	ENABLED	-	-	ENABLED																																																																																					
00A0	ENABLED	-	ENABLED	-																																																																																					
00B0	ENABLED	-	ENABLED	ENABLED																																																																																					
00C0	ENABLED	ENABLED	-	-																																																																																					
00D0	ENABLED	ENABLED	-	ENABLED																																																																																					
00E0	ENABLED	ENABLED	ENABLED	-																																																																																					
00F0	ENABLED	ENABLED	ENABLED	ENABLED																																																																																					
 6911																																																																																									
 6511																																																																																									
 6521		When using the standard 6511 and 6521 keypad, disabling the DIR key prevents the local setpoint going negative (for reverse). Similarly, disabling the L/R key prevents the drive being changed from Local to Remote, or Remote to Local modes.																																																																																							
55t98	APPLICATION LOCK F	Setting this parameter to TRUE prevents editing of parameter ^P 1. Set this parameter to FALSE to edit parameter ^P 1.	0=FALSE 1=TRUE	0																																																																																					
55t99	DETAILED MENUS	Selects Full menu detail when TRUE. The additional parameters in the Full menus are indicated in this table by F	0=FALSE 1=TRUE	0																																																																																					

MMI Parameters Table				
Display	Parameter	Description	Range	Default
SET::ENC Menu				
5EN01	ENC MODE F	Set this parameter to the requirements for your encoder: 0 : QUADRATURE (using digital inputs 6 & 7, ENCA and ENCB respectively) 1 : CLOCK/DIR (using digital inputs 6 & 7, ENCA and ENCB respectively) 2 : CLOCK (using digital input 6, ENCA)	0= QUADRATURE 1= CLOCK/DIR 2= CLOCK	0
5EN02	ENC RESET F	When TRUE the POSITION and SPEED outputs are set (and held) at zero.	0=FALSE 1=TRUE	0
5EN03	ENC INVERT F	When TRUE, changes the sign of the measured speed and the direction of the position count.	0=FALSE 1=TRUE	0
5EN04	ENC LINES F	The number of lines must be set to match the type of encoder being used. Incorrect setting of this parameter will result in an erroneous speed measurement.	100 to 10000	100
5EN05	ENC SPEED SCALE F	This parameter allows the output "speed" to be scaled to any value the user requires. With a default value of 1.00, the output "speed" is measured in revs per second. Changing the ENC SPEED SCALE value to 60.00 will provide an output in revs per minute. To provide an output in percent of the motor maximum speed, where maximum speed is the maximum speed your motor will run in rpm, the ENC SPEED SCALE parameter should be set to the result of: <div style="text-align: center; margin: 10px 0;">$\frac{6000}{\text{maximum speed (rpm)}}$</div>	0.00 to 300.00	1.00
5EN06	ENC SPEED F	Speed feedback, in units defined by the ENC SPEED SCALE parameter.	—.x	—.x

6-13 Programming Your Application

Configuring Terminals 9 & 10 (Digital Input/Output)

Terminal 10 can be operated as digital input DIN 4 or digital output DOUT2. It is configured via the keypad or DSE Lite (or other suitable programming tool). The default for terminal 10 is to operate as a digital input, and the input logic is non-inverted.

Terminal 9 can be operated as digital input DIN3 or digital output DOUT1, however, it can only be configured via DSE Lite (or other suitable programming tool). The default for terminal 9 is to operate as a digital input, and the input logic is non-inverted.

Configure for use as a Digital Input (default)

For example, to use terminal 10 as an input, the output circuitry must be disabled by setting ^SDOP2 and ^SOPD2 to zero. You can invert this logic using parameter ^SIP04.

Parameter	Setting
^S DOP2 DOUT2 SOURCE	0
^S OPD2 DOUT2 INVERT	0
^S IP04 DIN4 INVERT	Default is 0, setting to 1 inverts the input logic

Configure for use as a Digital Output

For example, to use terminal 10 as an output, select ^SDOP2 to be 1, 2, 3, 4, 5 or 6. For instance, you could set parameter ^SDOP2 to 3 to have the output go high (24V) whenever the motor is running, operating an external relay or lamp. You can invert this logic using parameter ^SOPD2.

Parameter	Setting	
^S DOP2 DOUT2 SOURCE	<p><i>The output is high when:</i></p> <p>1 = HEALTH The Run signal is not present, or no trip is active</p> <p>2 = TRIPPED A trip is present</p> <p>3 = RUNNING The motor is running</p>	
	4 = AT ZERO The output frequency is below 1% of MAX SPEED (^P 2)	
	5 = AT SPEED The output frequency is at or near Setpoint and within ±1% of MAX SPEED, set by (P2). For example: if MAX SPEED = 50Hz and Setpoint = 30Hz, then 1% of MAX SPEED = 0.5Hz. So AT LOAD is True between 30 ±0.5Hz.	
	6 = AT LOAD The magnitude of the output torque is greater than or equal to the torque level set in ^S ST42	
	7 = READY The drive is ready to start.	
	Always set ^S IP04 to 0 if using Applications 1 and 5 – refer to Chapter 12.	
	^S OPD2 DOUT2 INVERT	Default is 0, setting to 1 inverts the output logic

PID - Tuning Your Drive

This section relates to the use of Application 5.

Parameters *APQ1* to *AP11*: PID is used to control the response of any closed loop system. It is used specifically in system applications involving the control of drives to provide zero steady state error between Setpoint and Feedback, together with good transient performance.

Proportional Gain (*APQ1*)

This is used to adjust the basic response of the closed loop control system. The PI error is multiplied by the Proportional Gain to produce an output.

Integral (*APQ2*)

The Integral term is used to reduce steady state error between the setpoint and feedback values of the PI. If the integral is set to zero, then in most systems there will always be a steady state error.

Derivative (*APQ3*)

This is used to correct for certain types of control loop instability, and therefore improve response. It is sometimes used when heavy or large inertia rolls are being controlled. The derivative term has an associated filter to suppress high frequency signals.

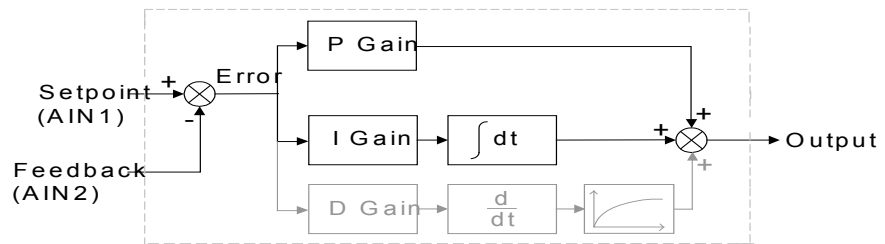

- Functions as P, PI, PID controller
- Single symmetric limit on output

A Method for Setting-up the PI Gains

The gains should be set-up so that a critically damped response is achieved for a step change in setpoint. An underdamped or oscillatory system can be thought of as having too much gain, and an overdamped system has too little.

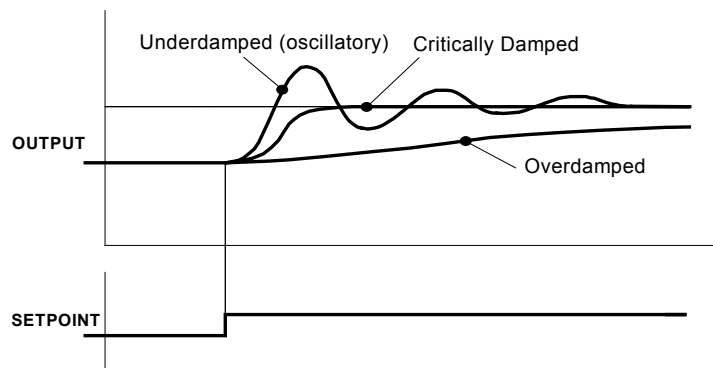

To set up the P gain, set the I gain to zero. Apply a step change in setpoint that is typical for the System, and observe the response. Increase the gain and repeat the test until the system becomes oscillatory. At this point, reduce the P gain until the oscillations disappear. This is the maximum value of P gain achievable.

If a steady state error is present, i.e. the feedback never reaches the setpoint value, the I gain needs to be increased. As before, increase the I gain and apply the step change. Monitor the output. If the output becomes oscillatory, reduce the P gain slightly. This should reduce the steady state error. Increasing the I gain further may reduce the time to achieve zero steady state error.

These values of P and I can now be adjusted to provide the exact response required for this step change.

6-15 Programming Your Application

Auto Restart

Parameters S5L21 to S5L24 provide the facility to automatically reset a choice of trip events and restart the drive with a programmed number of attempts. If the drive is not successfully started, a manual or remote trip reset is required.

The number of attempted restarts are recorded. This count is cleared after a trip-free period of operation (5 minutes or 4 x AUTO RESTART DELAY, whichever is the longer); or after a successful manual or remote trip reset; or by removing the Run signal (Terminal 7, DIN1).

Refer to Chapter 7: "Trips and Fault Finding" - Hexadecimal Representation of Trips.

Skip Frequencies

Parameters SST11 to SST14 control two programmable skip frequencies that can prevent the drive from operating at frequencies that cause mechanical resonance in the load.

- Enter the value of the frequency that causes the resonance into the SKIP FREQUENCY parameter.
- Enter a width for the skip band into the SKIP FREQUENCY BAND parameter.

The drive will then avoid sustained operation within the forbidden band as shown in the diagram. The skip frequencies are symmetrical and thus work in forward and reverse.

Setting SKIP FREQUENCY or SKIP FREQUENCY BAND to 0 disables the corresponding band.

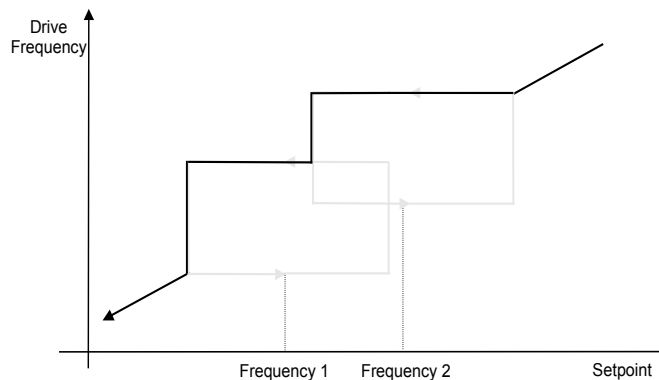
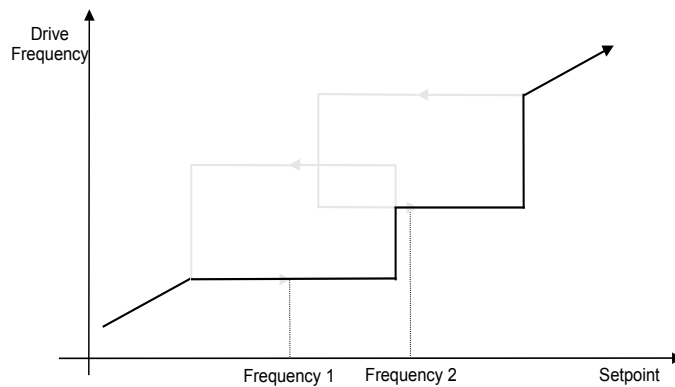
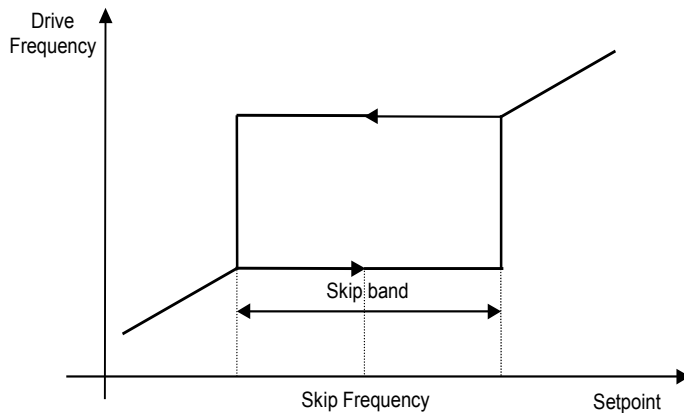

Minimum Speed Mode

There are two operating modes for the minimum speed feature.

Proportional with Minimum

In this mode the speed setpoint is clamped to be between the minimum speed value (P3) and 100%. This is the default for the minimum speed feature.

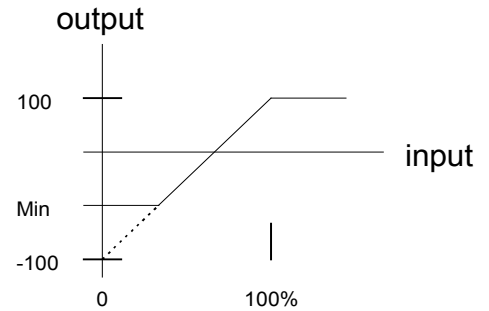

Linear

In this mode the speed setpoint is first clamped to be in the range 0 to 100%. It is then rescaled so that the output goes linearly between the minimum speed value (P3) and 100% for an input setpoint that goes between 0% and 100%. If the minimum speed value (P3) is negative the speed setpoint will be internally set to 0%.

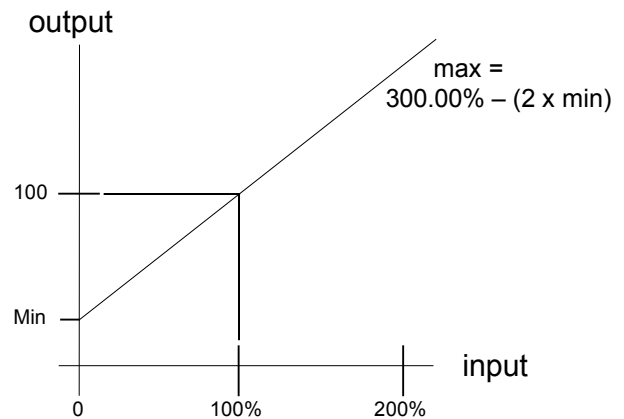

Product-Related Default Values

All examples given in this book are based on a UK, 230V, 50Hz, 0.25kW drive. This manual provides information about each parameter accessible using the keypad, or MMI (Man Machine Interface). For more information about these and additional parameters accessible using DSE Lite (or other suitable programming tool), refer to the 650V Software Product Manual on our web site: www.SSDdrives.com.

* Frequency Dependent Parameters

These parameter values (marked with "*" in the Application diagrams) are dependent upon the drive's "default frequency".

Changing the "default frequency" parameter from 50Hz to 60Hz, and vice versa, causes the values of the parameters in the table below to be changed.

To change the "default frequency", power-down the drive. Power-up the drive holding down the 'E' and DOWN keys on the keypad. Release the keys to display the ° 0.01 parameter.

Caution

You are now in a menu containing some sensitive and important parameters.

Press the UP key to display the ° 0.02 parameter. Press the M key. The values for this parameter are: 0 = 50Hz default, 1 = 60Hz default. Select the setting using the UP/DOWN keys and then press the E key. Power-down the drive and power-up again holding down the UP and DOWN keys. This resets **ALL** parameters to their correct default values, including Motor Parameters.

6-17 Programming Your Application

Frequency Dependent Defaults					
Display	Parameter	Function Block	Tag	50Hz Operation	60Hz Operation
P 7	BASE FREQUENCY	MOTOR DATA	1159	50Hz	60Hz
5CL02	NAMEPLATE RPM	MOTOR DATA	83	#	1750 RPM
5CL12	MOTOR VOLTAGE	MOTOR DATA	1160	*	*
P 2	MAX SPEED	REFERENCE	57	50Hz	60Hz
5CL16	MOTOR CONNECTION	MOTOR DATA	124	STAR	STAR

The correct value is selected for the size of drive - refer to the Power Dependent Parameters table below
 * The correct value is selected for the drive, however, when 60Hz is selected the 400V unit = 460V

** Power Dependent Parameters

These parameters (marked with “**”) in the Application diagrams) are set to a value depending on the drive's overall “power-build” indicated by the Product Code. We recommend that you do not change the Product Code.

230V Build Power Dependent Defaults								
Parameter	Function Block	Tag	Frame 1				Frame 2	
			0.25kW	0.37kW	0.55kW	0.75kW	1.1kW	1.5kW
POWER	MOTOR DATA	1158	0.25 kw	0.37 kw	0.55 kw	0.75 kw	1.10 kw	1.50 kw
MOTOR CURRENT	MOTOR DATA	64	1.50 A	2.20 A	3.00 A	4.00 A	5.50 A	7.00 A
MAG CURRENT	MOTOR DATA	65	0.80 A	0.80 A	1.04 A	1.36 A	2.50 A	3.41 A
NAMEPLATE RPM	MOTOR DATA	83	1380.0 RPM	1380.0 RPM	1400.0 RPM	1400.0 RPM	1420.0 RPM	1420.0 RPM
MOTOR VOLTAGE	MOTOR DATA	1160	230.0 V	230.0 V	230.0 V	230.0 V	230.0 V	230.0 V
POWER FACTOR	MOTOR DATA	242	0.70	0.70	0.70	0.70	0.71	0.78
STATOR RES	MOTOR DATA	119	5.2060 ohms	5.2060 ohms	3.8177 ohms	2.9367 ohms	1.5907 ohms	1.1687 ohms
LEAKAGE INDUC	MOTOR DATA	120	110.47 mH	110.47 mH	81.01 mH	62.32 mH	33.76 mH	24.80 mH
MUTUAL INDUC	MOTOR DATA	121	441.90 mH	441.90 mH	324.06 mH	249.28 mH	135.02 mH	99.20 mH
ROTOR TIME CONST	MOTOR DATA	1163	91.17 ms	91.17 ms	109.40 ms	109.40 ms	136.75 ms	136.75 ms
BRAKE POWER	DYNAMIC BRAKING	78	0.1 kW	0.1 kW	0.1 kW	0.1 kW	0.1 kW	0.1 kW
FREQUENCY	INJ BRAKING	577	9.0 Hz	9.0 Hz	9.0 Hz	9.0 Hz	9.0 Hz	9.0 Hz
DEFLUX TIME	INJ BRAKING	710	0.1 s	0.1 s	0.1 s	0.1 s	0.1 s	0.1 s
BASE VOLTS	INJ BRAKING	739	100.00 %	100.00 %	100.00 %	100.00 %	100.00 %	100.00 %
DC LEVEL	INJ BRAKING	581	10.0 %	10.0 %	10.0 %	10.0 %	3.0 %	3.0 %
DC PULSE	INJ BRAKING	579	2.0 s	2.0 s	2.0 s	2.0 s	2.0 s	2.0 s
FINAL DC PULSE	INJ BRAKING	580	1.0 s	1.0 s	1.0 s	1.0 s	1.0 s	1.0 s
FIXED BOOST	FLUXING	107	5.00%	5.00%	5.00%	5.00%	5.00%	5.00%
ACCEL TIME	REFERENCE RAMP	258	10.0 s	10.0 s	10.0 s	10.0 s	10.0 s	10.0 s
DECEL TIME	REFERENCE RAMP	259	10.0 s	10.0 s	10.0 s	10.0 s	10.0 s	10.0 s
DEFLUX DELAY	PATTERN GEN	100	0.5 s	0.5 s	0.5 s	0.5 s	1.0 s	1.0 s
SEARCH VOLTS	FLYCATCHING	573	9.00 %	9.00 %	9.00 %	9.00 %	9.00 %	9.00 %
SEARCH BOOST	FLYCATCHING	32	40.00 %	40.00 %	40.00 %	40.00 %	40.00 %	40.00 %
SEARCH TIME	FLYCATCHING	574	5.0 s	5.0 s	5.0 s	5.0 s	5.0 s	5.0 s
REFLUX TIME	FLYCATCHING	709	3.0 s	3.0 s	3.0 s	3.0 s	3.0 s	3.0 s
OVERLOAD	MOTOR DATA	1164	2.0	2.0	2.0	2.0	2.0	2.0
SPEED PROP GAIN	SPEED LOOP	1187	20	20	20	20	20	20
SPEED INT TIME	SPEED LOOP	1188	500. ms	500. ms	500. ms	500. ms	500. ms	500. ms
MOTOR CONNECTION	MOTOR DATA	124	1 : STAR	1 : STAR	1 : STAR	1 : STAR	1 : STAR	1 : STAR
BRAKE RESISTANCE	DYNAMIC BRAKING	77	500	500	500	500	500	500
BOOST MODE	FLUXING	1058	1	1	1	1	1	1

6-19 Programming Your Application

400V Build Power Dependent Defaults			Frame 2					
Parameter	Function Block	Tag	0.37kW	0.55kW	0.75kW	1.1kW	1.5kW	2.2kW
POWER	MOTOR DATA	1158	0.37 kw	0.55 kw	0.75 kw	1.10 kw	1.50 kw	2.20 kw
MOTOR CURRENT	MOTOR DATA	64	1.50 A	2.00 A	2.50 A	3.50 A	4.50 A	5.50 A
MAG CURRENT	MOTOR DATA	65	0.44 A	0.60 A	0.78 A	1.00 A	1.44 A	1.96 A
NAMEPLATE RPM	MOTOR DATA	83	1380.0 RPM	1400.0 RPM	1400.0 RPM	1420.0 RPM	1420.0 RPM	1420.0 RPM
MOTOR VOLTAGE	MOTOR DATA	1160	400.0 V	400.0 V	400.0 V	400.0 V	400.0 V	400.0 V
POWER FACTOR	MOTOR DATA	242	0.70	0.70	0.70	0.71	0.71	0.78
STATOR RES	MOTOR DATA	119	15.7459 ohms	11.5470 ohms	8.8823 ohms	1.5907 ohms	4.8113 ohms	3.5348 ohms
LEAKAGE INDUC	MOTOR DATA	120	334.14 mH	245.04 mH	188.49 mH	33.76 mH	102.10 mH	75.01 mH
MUTUAL INDUC	MOTOR DATA	121	1336.55 mH	980.14 mH	753.95 mH	135.02 mH	408.39 mH	300.04 mH
ROTOR TIME CONST	MOTOR DATA	1163	91.17 ms	109.40 ms	109.40 ms	136.75 ms	136.75 ms	136.75 ms
BRAKE POWER	DYNAMIC BRAKING	78	0.1 kW	0.1 kW	0.1 kW	0.1 kW	0.1 kW	0.1 kW
FREQUENCY	INJ BRAKING	577	9.0 Hz	9.0 Hz	9.0 Hz	9.0 Hz	9.0 Hz	9.0 Hz
DEFLUX TIME	INJ BRAKING	710	0.1 s	0.1 s	0.1 s	0.1 s	0.1 s	0.1 s
BASE VOLTS	INJ BRAKING	739	100.00 %	100.00 %	100.00 %	100.00 %	100.00 %	100.00 %
DC LEVEL	INJ BRAKING	581	3.0 %	3.0 %	3.0 %	3.0 %	3.0 %	3.0 %
DC PULSE	INJ BRAKING	579	2.0 s	2.0 s	2.0 s	2.0 s	2.0 s	2.0 s
FINAL DC PULSE	INJ BRAKING	580	1.0 s	1.0 s	1.0 s	1.0 s	1.0 s	1.0 s
FIXED BOOST	FLUXING	107	5.00%	5.00%	5.00%	5.00%	5.00%	5.00%
ACCEL TIME	REFERENCE RAMP	258	10.0 s	10.0 s	10.0 s	10.0 s	10.0 s	10.0 s
DECEL TIME	REFERENCE RAMP	259	10.0 s	10.0 s	10.0 s	10.0 s	10.0 s	10.0 s
DEFLUX DELAY	PATTERN GEN	100	1.0 s	1.0 s	1.0 s	1.0 s	1.0 s	1.0 s
SEARCH VOLTS	FLYCATCHING	573	9.00 %	9.00 %	9.00 %	9.00 %	9.00 %	9.00 %
SEARCH BOOST	FLYCATCHING	32	40.00 %	40.00 %	40.00 %	40.00 %	40.00 %	40.00 %
SEARCH TIME	FLYCATCHING	574	5.0 s	5.0 s	5.0 s	5.0 s	5.0 s	5.0 s
REFLUX TIME	FLYCATCHING	709	3.0 s	3.0 s	3.0 s	3.0 s	3.0 s	3.0 s
OVERLOAD	MOTOR DATA	1164	2.0	2.0	2.0	2.0	2.0	2.0
SPEED PROP GAIN	SPEED LOOP	1187	20	20	20	20	20	20
SPEED INT TIME	SPEED LOOP	1188	500. ms	500. ms	500. ms	500. ms	500. ms	500. ms
MOTOR CONNECTION	MOTOR DATA	124	1 : STAR	1 : STAR	1 : STAR	1 : STAR	1 : STAR	1 : STAR
BRAKE RESISTANCE	DYNAMIC BRAKING	77	500	500	500	200	200	200
BOOST MODE	FLUXING	1058	1	1	1	1	1	1

400V Build Power Dependent Defaults						
Parameter	Function Block	Tag	Frame 3			
POWER	MOTOR DATA	1158	3.00 kw	4.00 kw	5.50 kw	7.50 kw
MOTOR CURRENT	MOTOR DATA	64	6.80 A	9.00 A	12.00 A	16.00 A
MAG CURRENT	MOTOR DATA	65	2.36 A	3.36 A	3.39 A	4.38 A
NAMEPLATE RPM	MOTOR DATA	83	1420.0 RPM	1420.0 RPM	1445.0 RPM	1450.0 RPM
MOTOR VOLTAGE	MOTOR DATA	1160	400.0 V	400.0 V	400.0 V	400.0 V
POWER FACTOR	MOTOR DATA	242	0.8	0.8	0.8	0.8
STATOR RES	MOTOR DATA	119	2.0620 ohms	2.0620 ohms	1.3625 ohms	1.0545 ohms
LEAKAGE INDUC	MOTOR DATA	120	43.76 mH	43.76 mH	43.37 mH	33.57 mH
MUTUAL INDUC	MOTOR DATA	121	175.03 mH	175.03 mH	173.48 mH	134.27 mH
ROTOR TIME CONST	MOTOR DATA	1163	136.75 ms	136.75 ms	276.04 ms	303.65 ms
BRAKE POWER	DYNAMIC BRAKING	78	0.2 kW	0.2 kW	0.5 kW	0.5 kW
FREQUENCY	INJ BRAKING	577	9.0 Hz	9.0 Hz	9.0 Hz	9.0 Hz
DEFLUX TIME	INJ BRAKING	710	0.5 s	0.5 s	0.5 s	0.5 s
BASE VOLTS	INJ BRAKING	739	100.00 %	100.00 %	100.00 %	100.00 %
DC LEVEL	INJ BRAKING	581	3.0 %	3.0 %	3.0 %	3.0 %
DC PULSE	INJ BRAKING	579	2.0 s	2.0 s	2.0 s	2.0 s
FINAL DC PULSE	INJ BRAKING	580	1.0 s	1.0 s	1.0 s	1.0 s
FIXED BOOST	FLUXING	107	5.00%	5.00%	5.00%	5.00%
ACCEL TIME	REFERENCE RAMP	258	10.0 s	10.0 s	10.0 s	10.0 s
DECEL TIME	REFERENCE RAMP	259	10.0 s	10.0 s	10.0 s	10.0 s
DEFLUX DELAY	PATTERN GEN	100	2.0 s	2.0 s	2.0 s	2.0 s
SEARCH VOLTS	FLYCATCHING	573	9.00 %	9.00 %	9.00 %	9.00 %
SEARCH BOOST	FLYCATCHING	32	40.00 %	40.00 %	40.00 %	40.00 %
SEARCH TIME	FLYCATCHING	574	5.0 s	5.0 s	5.0 s	5.0 s
REFLUX TIME	FLYCATCHING	709	3.0 s	3.0 s	3.0 s	3.0 s
OVERLOAD	MOTOR DATA	1164	2.0	2.0	2.0	2.0
SPEED PROP GAIN	SPEED LOOP	1187	20	20	20	20
SPEED INT TIME	SPEED LOOP	1188	500. ms	500. ms	500. ms	500. ms
MOTOR CONNECTION	MOTOR DATA	124	1 : STAR	1 : STAR	1 : STAR	1 : STAR
BRAKE RESISTANCE	DYNAMIC BRAKING	77	100	100	56	56
BOOST MODE	FLUXING	1058	1	1	1	1

Chapter 7 TRIPS AND FAULT FINDING

Trips

Trip Warning Message

The trip display message is flashed repeatedly on the screen to warn of an imminent trip. Some trip conditions need time to take effect. The warning can allow you time to rectify the situation.

The message will clear when you use the keypad, but after a short time will reappear until the problem is resolved, or the drive trips.

What Happens when a Trip Occurs

When a trip occurs, the drive's power stage is immediately disabled causing the motor and load to coast to a stop. The trip is latched until action is taken to reset it. This ensures that trips due to transient conditions are captured and the drive is disabled, even when the original cause of the trip is no longer present.

Keypad Indications

If a trip condition is detected the activated alarm is displayed on the MMI display.

Resetting a Trip Condition

All trips must be reset before the drive can be re-enabled. A trip can only be reset once the trip condition is no longer active, i.e. a trip due to a heatsink over-temperature will not reset until the temperature is below the trip level.

You can reset the trip as follows:

1. Press the  (STOP) key to reset the trip and clear the alarm from the display.
2. Remove and then re-apply the RUN command and the drive will run normally.

In remote mode, success is indicated by displaying .

Using the Keypad to Manage Trips

Trip Messages

If the drive trips, then the display immediately shows a message indicating the reason for the trip. The possible trip messages are given in the table below.

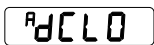
ID	Trip Name	Possible Reason for Trip
1	OVERVOLTAGE 	<i>The drive internal dc link voltage is too high:</i> <ul style="list-style-type: none"> • The supply voltage is too high • Trying to decelerate a large inertia load too quickly; DECEL TIME time too short The brake resistor is open circuit
2	UNDERVOLTAGE 	<i>DC link low trip:</i> Supply is too low/power down

Trips and Fault Finding 7-2

ID	Trip Name	Possible Reason for Trip
3	OVERCURRENT A OC	<p><i>The motor current being drawn from the drive is too high:</i></p> <ul style="list-style-type: none"> Trying to accelerate a large inertia load too quickly; ACCEL TIME time too short Trying to decelerate a large inertia load too quickly; DECEL TIME time too short Application of shock load to motor Short circuit between motor phases Short circuit between motor phase and earth Motor output cables too long or too many parallel motors connected to the drive FIXED BOOST level set too high
4	HEATSINK A H0t	<p><i>Drive heatsink temperature > 100°C:</i></p> <ul style="list-style-type: none"> The ambient air temperature is too high Poor ventilation or spacing between drives
5	EXTERNAL TRIP A Et	<p><i>The external trip input is high:</i></p> <ul style="list-style-type: none"> Check configuration to identify the source of the signal (non-standard configuration)
6	INVERSE TIME A It	<p><i>A prolonged overload condition, exceeding the Inverse Time allowance, has caused the trip:</i></p> <ul style="list-style-type: none"> Remove the overload condition - refer to Chapter 5: P12
7	CURRENT LOOP A LOOP	<p><i>A current of less than 1mA is present when 4-20mA setpoint is selected:</i></p> <ul style="list-style-type: none"> Look for a wire break
8	MOTOR STALLED A StLL	<p><i>The motor has stalled (not rotating) Drive in current limit >200 seconds:</i></p> <ul style="list-style-type: none"> Motor loading too great FIXED BOOST level set too high
9	ANIN FAULT A t 3	<p><i>AIN2 overload on terminal 3:</i></p> <ul style="list-style-type: none"> Overcurrent applied in Current mode to terminal 3
10	BRAKE RESISTOR A db r	<p><i>External dynamic brake resistor has been overloaded:</i></p> <ul style="list-style-type: none"> Trying to decelerate a large inertia too quickly or too often
11	BRAKE SWITCH A db S	<p><i>Internal dynamic braking switch has been overloaded:</i></p> <ul style="list-style-type: none"> Trying to decelerate a large inertia too quickly or too often
12	DISPLAY/KEYPAD A d ISP	<p><i>Keypad has been disconnected from drive whilst drive is running in Local Control:</i></p> <ul style="list-style-type: none"> Keypad accidentally disconnected from drive (indicated over Comms, or by second keypad)
13	LOST COMMS A SC1	<p><i>Lost communications:</i></p> <ul style="list-style-type: none"> COMMS TIMEOUT parameter set too short Master device failed Wiring broken Incorrect Comms setup

7-3 Trips and Fault Finding

ID	Trip Name	Possible Reason for Trip
14	CONTACTOR FBK A C N E C	<i>Contactor feedback signal lost:</i> <ul style="list-style-type: none"> Check connection to the terminal wired to "contactor closed" parameter in Sequencing Logic (non-standard configuration)
15	SPEED FEEDBACK A S P d	<i>Speed feedback:</i> <ul style="list-style-type: none"> SPEED ERROR > 50.00% for 10 seconds
17	MOTOR OVERTEMP A O t	<i>The motor temperature is too high:</i> <ul style="list-style-type: none"> Excessive load Motor voltage rating incorrect FIXED BOOST level set too high Prolonged operation of the motor at low speed without forced cooling Break in motor thermistor connection
18	CURRENT LIMIT A I H I	<i>Software overcurrent trip:</i> <ul style="list-style-type: none"> If the current exceeds 180% of stack rated current for a period of 1 second, the drive will trip. This is caused by shock loads. Remove the shock load. ACCEL TIME and/or FIXED BOOST set too high DECEL TIME set too low
21	LOW SPEED OVER I A L S P d	<i>The motor is drawing too much current (> 100%) at zero output frequency:</i> <ul style="list-style-type: none"> FIXED BOOST level set too high
22	10V FAULT A t 4	<i>10V fault:</i> <ul style="list-style-type: none"> +10V REF overload warning (terminal 4) - 10mA maximum
25	DC LINK RIPPLE A D C L R P	<i>The dc link ripple voltage is too high:</i> <ul style="list-style-type: none"> Check for a missing input phase
27	OVERSPEED A O S P d	<i>Overspeed:</i> <ul style="list-style-type: none"> > 150% base speed when in Sensorless Vector mode
28	ANOUT FAULT A t 5	<i>AOUT overload on terminal 5:</i> <ul style="list-style-type: none"> 10mA maximum
29	DIGIO 1 (T9) FAULT A t 9	<i>DIN3 overload on terminal 9:</i> <ul style="list-style-type: none"> 20mA maximum
30	DIGIO 2 (T10) FAULT A t 10	<i>DOUT2 overload on terminal 10:</i> <ul style="list-style-type: none"> 50mA maximum
31	UNKNOWN A t I P	Unknown trip
32	OTHER A t 32	"OTHER" trip is active (Trip ID 34 to 44 inclusive)
34	MAX SPEED LOW A t N 1	During Autotune the motor is required to run at the nameplate speed of the motor. If MAX SPEED RPM limits the speed to less than this value, an error will be reported. Increase the value of MAX SPEED RPM up to the nameplate rpm of the motor (as a minimum). It may be reduced, if required, after the Autotune is complete.

ID	Trip Name	Possible Reason for Trip
35	MAIN VOLTS LOW AEN2	The mains input voltage is not sufficient to carry out the Autotune. Re-try when the mains has recovered.
36	NOT AT SPEED AEN3	The motor was unable to reach the required speed to carry out the Autotune. Possible reasons include: <ul style="list-style-type: none"> motor shaft not free to turn the motor data is incorrect
37	MAG CURRENT FAIL AEN4	It was not possible to find a suitable value of magnetising current to achieve the required operating condition for the motor. Check the motor data is correct, especially nameplate rpm and motor volts. Also check that the motor is correctly rated for the drive.
38	NEGATIVE SLIP F AEN5	Autotune has calculated a negative slip frequency, which is not valid. Nameplate rpm may have been set to a value higher than the base speed of the motor. Check nameplate rpm, base frequency, and pole pairs are correct.
39	TR TOO LARGE AEN6	The calculated value of rotor time constant is too large. Check the value of nameplate rpm.
40	TR TOO SMALL AEN7	The calculated value of rotor time constant is too small. Check the value of nameplate rpm.
41	MAX RPM DATA ERR AEN8	This error is reported when the MAX SPEED RPM is set to a value outside the range for which Autotune has gathered data. Autotune gathers data on the motor characteristics up to 30% beyond "max speed rpm". If MAX SPEED RPM is later increased beyond this range, the drive had no data for this new operating area, and so will report an error. To run the motor beyond this point it is necessary to re-autotune with MAX SPEED RPM set to a higher value.
42	LEAKGE L TIMEOUT AEN9	The motor must be stationary when starting the Autotune
43	MOTOR TURNING ERR AEN10	The motor must be able to rotate during Autotune
44	MOTOR STALL ERR AEN11	The leakage inductance measurement requires a test current to be inserted into the motor. It has not been possible to achieve the required level of current. Check that the motor is wired correctly.
-	Product Code Error CODE	Switch unit off/on. If persistent, return unit to factory
-	Calibration Data Error CAL	Switch unit off/on. If persistent, return unit to factory
-	Configuration Data Error DATA	Press the E key to accept the default configuration. If persistent, return unit to factory

7-5 Trips and Fault Finding

Hexadecimal Representation of Trips

The tables below show the possible parameter values for the AUTO RESTART TRIGGERS and AUTO RESTART TRIGGERS+ parameters, ^SST23 and ^SST24 respectively. Refer to the 650V Software Product Manual, "Trips Status" (on our website: www.SSDdrives.com) for additional trip information that is available over the Comms.

Each trip has a unique, four-digit hexadecimal number number as shown in the tables below.

^S ST23 : AUTO RESTART TRIGGERS				
ID	Trip Name (MMI 6901)	Trip Name (MMI 6511 & 6521)	Mask	User Disable
1	OVERVOLTAGE	DCHI	0x0001	
2	UNDERVOLTAGE	DCLO	0x0002	
3	OVERCURRENT	OC	0x0004	
4	HEATSINK	HOT	0x0008	
5	EXTERNAL TRIP	ET	0x0010	✓
6	INVERSE TIME	<input type="text" value="51t"/>	0x0020	✓
7	CURRENT LOOP	<input type="text" value="5LOOP"/>	0x0040	✓
8	MOTOR STALLED	<input type="text" value="5StLL"/>	0x0080	✓
9	ANIN FAULT	<input type="text" value="5t3"/>	0x0100	✓
10	BRAKE RESISTOR	<input type="text" value="5dbf"/>	0x0200	✓
11	BRAKE SWITCH	<input type="text" value="5db5"/>	0x0400	✓
12	DISPLAY/KEYPAD	<input type="text" value="5dl5P"/>	0x0800	✓
13	LOST COMMS	SCI	0x1000	✓
14	CONTACTOR FBK	CNTC	0x2000	✓
15	SPEED FEEDBACK	<input type="text" value="5SPd"/>	0x4000	✓

^S ST24 : AUTO RESTART TRIGGERS+				
ID	Trip Name (MMI 6901)	Trip Name (MMI 6511 & 6521)	Mask +	User Disable
17	MOTOR OVERTEMP	<input type="text" value="50t"/>	0x0001	✓
18	CURRENT LIMIT	I HI	0x0002	
21	LOW SPEED OVER I	LSPD	0x0010	
22	10V FAULT	T 4	0x0020	✓
25	DC LINK RIPPLE	DCRP	0x0100	✓
27	OVERSPEED	<input type="text" value="50SPd"/>	0x0400	✓
28	ANOUT FAULT	T 5	0x0800	✓
29	DIGIO 1 (T9) FAULT	T 9	0x1000	✓
30	DIGIO 2 (T10) FAULT	T 10	0x2000	✓
31	UNKNOWN	TRIP	0x4000	
32	OTHER	TR32	0x8000	
34	MAX SPEED LOW	ATN1	0x8000	N/A
35	MAIN VOLTS LOW	ATN2	0x8000	N/A
36	NOT AT SPEED	ATN3	0x8000	N/A
37	MAG CURRENT FAIL	ATN4	0x8000	N/A
38	NEGATIVE SLIP F	ATN5	0x8000	N/A
39	TR TOO LARGE	ATN6	0x8000	N/A
40	TR TOO SMALL	ATN7	0x8000	N/A
41	MAX RPM DATA ERR	ATN8	0x8000	N/A
42	LEAKGE L TIMEOUT	ATN9	0x8000	N/A

ST24 : AUTO RESTART TRIGGERS+				
ID	Trip Name (MMI 6901)	Trip Name (MMI 6511 & 6521)	Mask +	User Disable
43	MOTOR TURNING ERR	ATNA	0x8000	N/A
44	MOTOR STALL ERR	ATNB	0x8000	N/A

Keypads (MMIs):

Trips shown as MMI displays in the tables above, i.e. **5LOOP**, can be disabled using the keypads in the TRIPS menu. Other trips, as indicated, can be disabled over the Comms.



6901



6511



6521



6911

Hexadecimal Representation of Trips

When more than one trip is to be represented at the same time then the trip codes are simply added together to form the value displayed. Within each digit, values between 10 and 15 are displayed as letters A to F

Decimal number	Display
10	A
11	B
12	C
13	D
14	E
15	F

For example referring to the tables above, if the AUTO RESTART TRIGGERS parameter is set to **04A0**, then this represents:

- a “4” in digit 3
- an “8” and a “2” in digit 2
(8+2 = 10, displayed as **A**)
- an “0” in digit 1

This in turn represents the trips BRAKE SWITCH, ANIN FAULT, MOTOR STALLED and INVERSE TIME.

In the same way, the AUTO RESTART TRIGGERS+ parameter set to **04A0** would represent OVERSPEED, ANIN FAULT, DESAT OVER I and 10V FAULT.

Fault Finding

Problem	Possible Cause	Remedy
Drive will not power-up	Fuse blown	Check supply details, fit correct fuse. Check Product Code against Model No.
	Faulty cabling	Check all connections are correct/secure. Check cable continuity
Drive fuse keeps blowing	Faulty cabling or connections wrong	Check for problem and rectify before replacing with correct fuse
	Faulty drive	Contact Parker SSD Drives
Cannot obtain power-on state	Incorrect or no supply available	Check supply details
Motor will not run at switch-on	Motor jammed	Stop the drive and clear the jam
Motor runs and stops	Motor becomes jammed	Stop the drive and clear the jam
	Open circuit speed reference potentiometer	Check terminal

Chapter 8 ROUTINE MAINTENANCE & REPAIR

Routine Maintenance

Periodically inspect the drive for build-up of dust or obstructions that may affect ventilation of the unit. Remove this using dry air.

Repair

There are no user-serviceable components.

IMPORTANT: MAKE NO ATTEMPT TO REPAIR THE UNIT - RETURN IT TO PARKER SSD DRIVES.

Saving Your Application Data

In the event of a repair, application data will be saved whenever possible. However, we advise you to copy your application settings before returning the unit.

Returning the Unit to Parker SSD Drives

Please have the following information available:

- The model and serial number - see the unit's rating label
- Details of the fault

Contact your nearest Parker SSD Drives Service Centre to arrange return of the item.

You will be given a *Returned Material Authorisation*. Use this as a reference on all paperwork you return with the faulty item. Pack and despatch the item in the original packing materials; or at least an anti-static enclosure. Do not allow packaging chips to enter the unit.

Disposal

This product contains materials which are consignable waste under the Special Waste Regulations 1996 which complies with the EC Hazardous Waste Directive - Directive 91/689/EEC.

We recommend you dispose of the appropriate materials in accordance with the valid environmental control laws. The following table shows which materials can be recycled and which have to be disposed of in a special way.

Material	Recycle	Disposal
metal	yes	no
plastics material	yes	no
printed circuit board	no	yes

The printed circuit board should be disposed of in one of two ways:

1. High temperature incineration (minimum temperature 1200°C) by an incinerator authorised under parts A or B of the Environmental Protection Act
2. Disposal in an engineered land fill site that is licensed to take aluminium electrolytic capacitors. Do not dispose of in a land fill site set aside for domestic waste.

Packaging

During transport our products are protected by suitable packaging. This is entirely environmentally compatible and should be taken for central disposal as secondary raw material.

Chapter 9 TECHNICAL SPECIFICATIONS

Understanding the Product Code

Model Number (Europe)

The unit is fully identified using a four block alphanumeric code which records how the drive was calibrated, and its various settings when despatched from the factory.

The Product Code appears as the “Model No.” on the product rating label. Each block of the Product Code is identified as shown below.

The example below shows this is a Frame 2 650V, 230v single phase, 1.5kW, no auxiliary supply, no brake switch, no filter, RS232 port fitted, panel mounted, no special options, English 50Hz, 6511 keypad option fitted.

	Block 1	Block 2	Block 3	Block 4
Example:	650V	- 21 1700 2 0	- 0 0 1 P 00	- A 1
Family	650V Sensorless vector range	650V		
		Heavy Duty	Standard Duty	Frame Size
Rating Data	Supply Voltage	kW/A	HP/A	kW/A
	230v 1/3phase	0.25/1.5	0.3/1.5	0.37/2.2
		0.55/3.0	0.75/3.0	0.75/4.0
		1.1/5.5	1.5/5.5	1.5/7.0
	230v 1/3phase	2.2/9.6	3.0/9.6	
	230v 3phase	3/12.3	4/12.3	4/16.4
		4/16.4	5/16.4	
	400/460v 3phase	0.37/1.5	0.5/1.5	0.75/2.5
		1.1/3.5	1.5/3.5	1.5/4.5
		2.2/5.5	3/5.5	3/6.8
		4/9	5/9	5.5/12
		7.5/16	10/16	
Auxiliary supply	Not required (frames 1-3 & frames C-E)			0
	115v 1ph (Frame F only)			1
	230v 1ph (Frame F only)			2
Brake Switch	Not Fitted (mandatory on F 1 & F 2 230v , optional on Frames D-F)			0
	Fitted (mandatory on F 2 400v & all F 3 & C, optional on Frames D-F)			B
Filter	Not fitted (Optional on frames 1-3, mandatory on frames C-F)			0
	Filter fitted (Optional on frames 1-3 only)			F
Comms	RS232 port fitted			1
	RS232 + RS485 ports fitted (Frames C-F only)			2
Mechanical style	Panel Mount			P
	Wall Mount (option on Frames C-E only)			W
	Through Panel Mount (Option on Frames C-E only)			T
Special Option	None			00
	Documented special options (01-99)			
Destination	English (50Hz)			A
	English (60Hz)			B
	German			D
	Spanish			E
	French			F
	Italian			I
	Swedish			S
Keypad	None			0
	6511 TTL fitted (option on frames 1-3 only)			1
	6511 RS232 fitted (option on frames 1-3 only)			2
	6521 fitted (option on Frames C-F only)			3

9-2 Technical Specifications

US Catalog Number & Legacy Product Code

The unit is identified using a 4 block alphanumeric code which records how the drive was calibrated, and its various settings when dispatched from the factory. All drives are in Standard Parker SSD Drives Livery and operate on 50/60Hz.

The Product Code appears as the “Cat No.”. Each block of the Product Code is identified as below:

650V/00F3/230/SNF
Block 1 2 3 4
example product code

Frame 1, 2, 3 – Catalog Number (North America)		
Block No.	Variable	Description
1	650V	Generic product
2	XXXX	Four characters specifying the power output in Hp: 00F3 = 0.3Hp 01F5 = 1.5Hp 0005 = 5Hp 00F5 = 0.5Hp 0002 = 2Hp 0007 = 7Hp 00F7 = 0.75Hp 0003 = 3Hp 0010 = 10Hp 0001 = 1Hp
3	XXX	Three numbers specifying the nominal input voltage rating: 230 230 (±10%) 50/60Hz 460 380 to 460V (±10%) 50/60Hz
4	X	One character specifying the use of the Keypad: S = Standard Keypad fitted R = Remote Keypad fitted
	X	Indicates if the drive is fitted with the Brake Switch N = Brake switch not fitted (230V Frames 1 & 2) B = Brake switch fitted (460V Frames 2 & 3)
	X	One character specifying the use of the Internal RFI Filter: N = Not fitted F = Internal Supply Filter fitted

Environmental Details	
Operating Temperature	0°C to 40°C
Storage Temperature	-25°C to +55°C
Shipping Temperature	-25°C to +70°C
Product Enclosure Rating	IP20 (UL Open Type) suitable for cubicle mount only
Cubicle Rating	Cubicle to provide 15dB attenuation to radiated emissions between 30-100MHz. It must also require a security tool for opening
Altitude	If > 1000 metres (3300 feet) above sea level, derate Motor Power Rating by 1% per 100 metres (330 feet) to a maximum of 2000 metres (6561 feet)
Humidity	Maximum 85% relative humidity at 40°C non-condensing
Atmosphere	Non flammable, non corrosive and dust free
Climatic Conditions	Class 3k3, as defined by EN50178 (1998)
Vibration	Test Fc of EN60068-2-6 10Hz ≤ f ≤ 57Hz sinusoidal 0.075mm amplitude 57Hz ≤ f ≤ 150Hz sinusoidal 1g 10 sweep cycles per axis on each of three mutually perpendicular axis
Safety	
Pollution Degree	Pollution Degree II (non-conductive pollution, except for temporary condensation)
Overvoltage Category	Overvoltage Category III (numeral defining an impulse withstand level)

Power Details	
1-Phase Supply	220-240V ac ±10%, 50/60Hz ±10%, ground referenced (TN) or non-ground referenced (IT)
3-Phase Supply	220-240V ac or 380-460V ac ±10%, 50/60Hz ±10%, ground referenced (TN) or non-ground referenced (IT)
Supply Power Factor (lag)	0.9 (@ 50/60Hz)
Output Frequency	0 – 240Hz
Switching Frequency	Nominal 3kHz
Overload	150% for 30 seconds
Supply Short Circuit Rating	220-240V 1φ product - 5000A, 220-240V ac 3φ product - 7500A 380-460V 3φ product - 10000A

9-4 Technical Specifications

Electrical Ratings

Motor power, output current and input current must not be exceeded under steady state operating conditions.

Maximum Motor $dv/dt = 10,000V/\mu s$. This can be reduced by adding a motor choke in series with the motor. Contact Parker SSD Drives for recommended choke details.

Local wiring regulations always take precedence. Select cable rated for the drive.

The supply must be protected with a fuse (or Type B RCD) rated to the supply cable.

FRAME 1 : 1-Phase (IT/TN), 230V

Drive Power (kW/hp)	Input Current @ 5kA		Output Current @ 40°C (A) ac	Maximum Power Loss (W)
	Surge Current peak/rms for 10ms (A)	(A)		
0.25/0.3	19/12	4.2	1.5	26
0.37/0.5	19/12	6.2	2.2	32
0.55/0.75	20/14	7.9	3.0	41
0.75/1.0	22/15	10.5	4.0	52

FRAME 2 : 1-Phase (IT/TN), 230V

Drive Power (kW/hp)	Input Current @ 5kA		Output Current @ 40°C (A) ac	Maximum Power Loss (W)
	Surge Current peak/rms for 10ms (A)	(A)		
1.1/1.5	24/17	13.8	5.5	65
1.5/2.0	25/18	16.0	7.0	82

FRAME 2 : 3-Phase (IT/TN), 400V

Drive Power (kW/hp)	Input Current @ 10kA (A)	Output Current @ 40°C (A) ac	Maximum Power Loss (W)
0.37/0.5	2.5	1.5	26
0.55/0.75	3.3	2.0	32
0.75/1.0	4.1	2.5	40
1.1/1.5	5.9	3.5	55
1.5/2.0	7.5	4.5	61
2.2/3.0	9.4	5.5	70

FRAME 3 : 1-Phase (IT/TN), 230V

Drive Power (kW/hp)	Input Current @ 7.5kA (A)	Output Current @ 40°C (A) ac	Maximum Power Loss (W)
2.2/3.0	22.0	9.6	112

FRAME 3 : 3-Phase (IT/TN), 230V

Drive Power (kW/hp)	Input Current @ 7.5kA (A)	Output Current @ 40°C (A) ac	Maximum Power Loss (W)
2.2/3.0	14.3	9.6	103
3.0/4.0	18.1	12.3	133
4.0/5.0	23.1	16.4	180

FRAME 3 : 3-Phase (IT/TN), 400V

Drive Power (kW/hp)	Input Current @ 10kA (A)	Output Current @ 40°C (A) ac	Maximum Power Loss (W)
3.0/4.0	11.1	6.8	80
4.0/5.0	13.9	9.0	100
5.5/7.5	18.0	12.0	136
7.5/10.0	23.6	16.0	180

Supply Short Circuit Rating

Products may be used on 50kA supplies provided an additional supply inductor is fitted, see tables below for further information:

230V

Frame Size	Motor Power	SSD Drives Part Number	MTE Part Number	Inductance mH	Rated amps
1	0.75kW 1Hp	CO470653	RL-00401	3.00	4
2	1.5kW 2Hp	CO353011	RL-00801	1.50	8
3	2.2kW 3Hp	CO470638	RL-01201	1.25	12
3	4kW 5HP	CO353012	RL-01801	0.80	18

460V

Frame Size	Motor Power	SSD Drives Part Number	MTE Part Number	Inductance mH	Rated amps
2	0.75kW 1Hp	CO470650	RL-00201	12.00	2
2	1.5kW 2Hp	CO470651	RL-00402	6.50	4
2	2.2kW 3Hp	CO352782	RL-00803	5.00	8
3	4kW 5Hp	CO470652	RL-00802	3.00	8
3	5.5kW 7.5Hp	CO352783	RL-01202	2.50	12
3	6.0kW 10Hp	CO352785	RL-01802	1.50	18
3	7.5kW 10Hp	CO352785	RL-01802	1.50	18

User Relay

RL1A, RL1B.

Maximum Voltage	250Vac
Maximum Current	4A
Sample Interval	10ms

Analog Inputs/Outputs

AIN1 and AIN2

Range	0-10V and 0-5V (no sign) set via parameter ^S IP13 (AIN1) 0-10V, 0-5V, 0-20mA or 4-20mA (no sign) set via parameter ^S IP23 (AIN2) Absolute maximum input current 25mA in current mode Absolute maximum input voltage 24V dc in voltage mode
Nominal Input Impedance	40k impedance in voltage mode, <6V @ 20mA in current mode
Resolution	10 bits, (1 in 1024)
Dynamic Response	Sampled every 5ms

Analog Outputs

AOUT1 and AOUT2

Range	0-10V (no sign) Maximum rated output current 10mA, with short circuit protection
Resolution	10 bits, (1 in 1024)
Dynamic Response	Updated every 5ms Bandwidth 15Hz

9-6 Technical Specifications

Digital Inputs		
Operating Range	DIN1, DIN2, DIN3, DIN4, DIN5: 0-5V dc = OFF, 15-24V dc = ON (absolute maximum input voltage $\pm 30V$ dc) IEC1131 DIN6, DIN7: 0-1.5V dc = OFF, 4-24V dc = ON (absolute maximum input voltage $\pm 30V$ dc) IEC1131	
Input Current	7.5mA @ 24V	
Sample Interval	10ms	

Digital Outputs	
DOUT1 and DOUT2	
Nominal Open Circuit Output Voltage	23V (minimum 19V)
Nominal Output Impedance	47 Ω
Rated Output Current	50mA <i>(either individually or as the sum of outs from terminals 6, 10 & 11)</i>

Cabling Requirements for EMC Compliance				
	Power Supply Cable	Motor Cable	Brake Resistor Cable	Signal/Control Cable
Cable Type (for EMC Compliance)	Unscreened	Screened/armoured	Screened/armoured	Screened
Segregation	From all other wiring (clean)	From all other wiring (noisy)		From all other wiring (sensitive)
Length Limitations With Internal AC Supply EMC Filter	Unlimited	*25 metres	25 metres	25 metres
Length Limitations Without Internal AC Supply EMC Filter	Unlimited	25 metres	25 metres	25 metres
Screen to Earth Connection		Both ends	Both ends	Drive end only
Output Choke		300 metres maximum		
* Maximum motor cable length under any circumstances				

Internal Dynamic Braking Circuit

The dynamic braking circuit is intended for with short term stopping or braking.

Motor Power (kW/Hp)	Brake Switch Peak Current (A)	Brake Switch Continuous Current (A)	Peak Brake Dissipation (kW/Hp)	Minimum Brake Resistor Value (Ω)
Frame 2 : 3 Phase (IT/TN), 400V, 100% duty DC link brake voltage : 750V				
0.37/0.5	1.5	1.5	1.1/1.5	500
0.55/0.75	1.5	1.5	1.1/1.5	500
0.75/1.0	1.5	1.5	1.1/1.5	500
1.1/1.5	1.5	1.5	1.1/1.5	500
1.5/2.0	3.75	3.75	2.8/3.75	200
2.2/3.0	3.75	3.75	2.8/3.75	200
Frame 3 : 1 Phase (IT/TN), 230V, 100% duty				
2.2/3.0	7.0	7.0	2.72	56
Frame 3 : 3 Phase (IT/TN), 230V, 100% duty DC link brake voltage : 390V				
2.2/3.0	7.0	7.0	2.72	56
3.0/4	10.8	10.8	4.23	36
4.0/5	14.0	14.0	5.44	28
Frame 3 : 3 Phase (IT/TN), 400V, 30% duty DC link brake voltage : 750V				
3.0/4	7.5	2.3	5.6/7.5	100
4.0/5	7.5	2.3	5.6/7.5	100
5.5/7.5	13.5	4.0	10/13.4	56
7.5/10	13.5	4.0	10/13.4	56

External Brake Resistor

All 650V units are supplied without braking resistors. The dynamic brake switch terminals (where fitted) allow easy connection to an external resistor. These resistors should be mounted on a heatsink (back panel) and covered to prevent injury from burning.

Recommended Brake Resistors

The following brake resistors are available from Parker SSD Drives:

Brake Resistor Value : Frame 2 : 200Ω, 100W - CZ467714; 500Ω, 60W - CZ467715
 Frame 3 : 28Ω, 500W (2 x 56Ω in parallel) - CZ467716; 36Ω, 500W - CZ388396;
 56Ω, 500W - CZ467716; 100Ω, 200W - CZ467717

Alternative Brake Resistor Selection

Brake resistor assemblies must be rated to absorb both peak braking power during deceleration and the average power over the repeated cycles.

$$\text{Peak braking power } P_{pk} = \frac{0.0055 \times J \times (n_1^2 - n_2^2)}{t_b} \quad (\text{W})$$

$$\text{Average braking power } P_{av} = \frac{P_{pk}}{t_c} \times t_b$$

- J - total inertia (kgm²)
- n₁ - initial speed (rpm)
- n₂ - final speed (rpm)
- t_b - braking time (s)
- t_c - cycle time (s)

Obtain information on the peak power rating and the average power rating of the resistors from the resistor manufacturer. If this information is not available, a large safety margin must be incorporated to ensure that the resistors are not overloaded. By connecting these resistors in series and in parallel the braking capacity can be selected for the application.

IMPORTANT: The minimum resistance of the combination and maximum dc link voltage must be as specified.

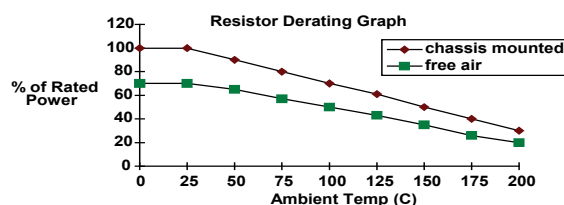

9-8 Technical Specifications

Supply Harmonic Analysis (230V filtered)

Assumptions: (Short circuit fault to Neutral)

5kA short circuit supply capability at 230V 1 ϕ , equivalent to 146 μ H supply impedance

7.5kA short circuit supply capability at 230V 3 ϕ , equivalent to 56 μ H supply impedance

10kA short circuit supply capability at 400V 3 ϕ , equivalent to 73 μ H supply impedance

$$THD(V) \times 100 = \frac{\sqrt{\sum_{h=2}^{h=40} Q_h^2}}{Q_{1n}} \%$$

where Q_{1n} is the rated rms value of the fundamental voltage of the supply transformer.

The results conform to stage 1 and stage 2 of the Engineering Recommendation G.5/4 February 2001, Classification 'C': Limits for Harmonics in the UK Electricity Industry.

Drive Type	650V								
Motor Power (kW)	0.25	0.37	0.55	0.75	1.1	1.5	2.2	3.0	4.0
Fundamental Voltage (V)	230	230	230	230	230	230	230	230	230
Typical Motor Efficiency %	85	85	85	85	85	85	85	85	85
Harmonic No.	RMS Current (A)								
1	7.4	7.5	7.8	8.2	9.0	10.3	TBA	TBA	TBA
3	1.4	0.2	1.9	2.2	2.9	3.9			
5	2.9	0.4	4.4	4.6	4.8	5.2			
7	1.1	0.5	1.9	2.0	2.3	2.5			
9	0.2	0.2	0.2	0.3	0.4	0.4			
11	0.1	0.1	0.2	0.2	0.2	0.3			
13	0.0	0.1	0.1	0.1	0.1	0.1			
15	0.1	0.0	0.1	0.1	0.1	0.1			
17	0.0	0.1	0.0	0.0	0.0	0.1			
19	0.0	0.0	0.0	0.0	0.0	0.1			
21	0.0	0.0	0.0	0.0	0.0	0.1			
23	0.0	0.0	0.0	0.0	0.0	0.0			
25	0.0	0.0	0.0	0.0	0.0	0.0			
27	0.0	0.0	0.0	0.0	0.0	0.0			
29	0.0	0.0	0.0	0.0	0.0	0.0			
31	0.0	0.0	0.0	0.0	0.0	0.0			
33	0.0	0.0	0.0	0.0	0.0	0.0			
35	0.0	0.0	0.0	0.0	0.0	0.0			
37	0.0	0.0	0.0	0.0	0.0	0.0			
39	0.0	0.0	0.0	0.0	0.0	0.0			
40	0.0	0.0	0.0	0.0	0.0	0.0			
Total RMS Current (A)	8.2	7.5	9.3	9.9	10.9	12.5			
THD (V) %	0.3559	0.0972	0.5426	0.5733	0.6277	0.7055			

Supply Harmonic Analysis (400V filtered)

Assumptions: (Short circuit fault to Neutral)
 5kA short circuit supply capability at 230V 1φ, equivalent to 146μH supply impedance
 7.5kA short circuit supply capability at 230V 3φ, equivalent to 56μH supply impedance
 10kA short circuit supply capability at 400V 3φ, equivalent to 73μH supply impedance

$$THD(V) \times 100 = \frac{\sqrt{\sum_{h=2}^{h=40} Q_h^2}}{Q_{1n}} \%$$

where Q_{1n} is the rated rms value of the fundamental voltage of the supply transformer.
 The results conform to stage 1 and stage 2 of the Engineering Recommendation G.5/4 February 2001,
 Classification 'C': Limits for Harmonics in the UK Electricity Industry.

Drive Type	650V									
Motor Power (kW)	0.37	0.55	0.75	1.1	1.5	2.2	3.0	4.0	5.5	7.5
Fundamental Voltage (V)	400	400	400	400	400	400	400	400	400	400
Typical Motor Efficiency %	85	85	85	85	85	85	85	85	85	85
Harmonic No.	RMS Current (A)									
1	0.6	1.0	1.3	1.9	2.6	3.8	5.2	6.9	9.5	12.9
3	0.0	0.0	0.0	0.0	0.0	0.0	0.0	0.0	0.0	0.0
5	0.6	0.9	1.2	1.8	2.4	3.5	4.7	6.2	8.3	11.1
7	0.6	0.9	1.2	1.7	2.3	3.3	4.3	5.5	7.3	9.5
9	0.0	0.0	0.0	0.0	0.0	0.0	0.0	0.0	0.0	0.0
11	0.5	0.8	1.0	1.5	1.9	2.6	3.3	3.9	4.8	5.7
13	0.0	0.7	0.9	1.3	1.6	2.2	2.7	3.0	3.5	3.9
15	0.4	0.0	0.0	0.0	0.0	0.0	0.0	0.0	0.0	0.0
17	0.4	0.6	0.7	1.0	1.1	1.4	1.6	1.5	1.4	1.2
19	0.0	0.5	0.6	0.9	0.9	1.1	1.1	0.9	0.8	0.7
21	0.3	0.0	0.0	0.0	0.0	0.0	0.0	0.0	0.0	0.0
23	0.2	0.3	0.4	0.6	0.5	0.5	0.4	0.3	0.5	0.7
25	0.0	0.3	0.3	0.4	0.3	0.3	0.2	0.4	0.5	0.7
27	0.1	0.0	0.0	0.0	0.0	0.0	0.0	0.0	0.0	0.0
29	0.1	0.2	0.2	0.2	0.1	0.2	0.3	0.4	0.4	0.4
31	0.0	0.1	0.1	0.1	0.1	0.2	0.3	0.3	0.3	0.3
33	0.1	0.0	0.0	0.0	0.0	0.0	0.0	0.0	0.0	0.0
35	0.0	0.1	0.1	0.1	0.1	0.2	0.2	0.2	0.2	0.3
37	0.0	0.1	0.1	0.1	0.1	0.2	0.1	0.1	0.2	0.3
39	0.0	0.0	0.0	0.0	0.0	0.0	0.0	0.0	0.0	0.0
40	0.0	0.0	0.0	0.0	0.0	0.0	0.0	0.0	0.0	0.0
Total RMS Current (A)	1.4	2.1	2.8	4.0	5.1	7.2	9.5	12.0	15.8	20.8
THD (V) %	0.1561	0.2158	0.2776	0.3859	0.4393	0.5745	0.6994	0.8111	0.9899	1.2110

9-10 Technical Specifications

Supply Harmonic Analysis (230V unfiltered)

Assumptions: (Short circuit fault to Neutral)

5kA short circuit supply capability at 230V 1 ϕ , equivalent to 146 μ H supply impedance

7.5kA short circuit supply capability at 230V 3 ϕ , equivalent to 56 μ H supply impedance

10kA short circuit supply capability at 400V 3 ϕ , equivalent to 73 μ H supply impedance

$$THD(V) \times 100 = \frac{\sqrt{\sum_{h=2}^{h=40} Q_h^2}}{Q_{1n}} \%$$

where Q_{1n} is the rated rms value of the fundamental voltage of the supply transformer.

The results conform to stage 1, stage 2 and stage 3 of the Engineering Recommendation G.5/3 September 1976, Classification 'C': Limits for Harmonics in the UK Electricity Industry.

Drive Type	650V								
Motor Power (kW)	0.25	0.37	0.55	0.75	1.1	1.5	2.2	3.0	4.0
Fundamental Voltage (V)	230	230	230	230	230	230	230	230	230
Typical Motor Efficiency %	85	85	85	85	85	85	85	85	85
Harmonic No.	RMS Current (A)								
1	1.3	2.0	2.9	3.9	5.7	7.8	TBA	TBA	TBA
3	1.3	1.9	2.9	3.8	5.5	7.4			
5	1.2	1.9	2.7	3.5	5.0	6.7			
7	1.1	1.7	2.5	3.1	4.4	5.4			
9	1.1	1.6	2.2	2.7	3.7	4.6			
11	1.0	1.4	1.9	2.2	2.9	3.4			
13	0.8	1.2	1.6	1.6	2.1	2.3			
15	0.7	1.0	1.3	1.2	1.4	1.4			
17	0.6	0.8	1.0	0.8	0.8	0.7			
19	0.5	0.7	0.7	0.4	0.4	0.3			
21	0.4	0.5	0.5	0.2	0.2	0.4			
23	0.3	0.3	0.3	0.2	0.3	0.4			
25	0.2	0.2	0.1	0.2	0.3	0.4			
27	0.1	0.1	0.1	0.2	0.3	0.3			
29	0.1	0.1	0.1	0.2	0.2	0.2			
31	0.0	0.1	0.1	0.1	0.1	0.1			
33	0.0	0.1	0.1	0.1	0.1	0.2			
35	0.0	0.1	0.1	0.1	0.1	0.2			
37	0.1	0.1	0.1	0.1	0.1	0.1			
39	0.0	0.1	0.1	0.1	0.1	0.1			
40	0.0	0.0	0.0	0.0	0.0	0.0			
Total RMS Current (A)	3.2	4.8	6.7	8.3	11.7	15.3			
THD (V) %	0.5633	0.8016	1.0340	1.0944	1.4611	1.7778			

Supply Harmonic Analysis (400V unfiltered)

Assumptions: (Short circuit fault to Neutral)

5kA short circuit supply capability at 230V 1φ, equivalent to 146μH supply impedance

7.5kA short circuit supply capability at 230V 3φ, equivalent to 56μH supply impedance

10kA short circuit supply capability at 400V 3φ, equivalent to 73μH supply impedance

$$THD(V) \times 100 = \frac{\sqrt{\sum_{h=2}^{h=40} Q_h^2}}{Q_{1n}} \%$$

where Q_{1n} is the rated rms value of the fundamental voltage of the supply transformer.

The results conform to stage 1, stage 2 and stage 3 of the Engineering Recommendation G.5/3 September 1976, Classification 'C': Limits for Harmonics in the UK Electricity Industry.

Drive Type	650V									
Motor Power (kW)	0.37	0.55	0.75	1.1	1.5	2.2	3.0	4.0	5.5	7.5
Fundamental Voltage (V)	400	400	400	400	400	400	400	400	400	400
Typical Motor Efficiency %	85	85	85	85	85	85	85	85	85	85
Harmonic No.	RMS Current (A)									
1	0.6	0.9	1.3	1.9	2.6	3.8	5.2	6.9	9.5	12.7
3	0.0	0.0	0.0	0.0	0.0	0.0	0.0	0.0	0.0	0.0
5	0.6	0.9	1.2	1.8	2.4	3.6	4.7	6.3	8.4	11.0
7	0.6	0.9	1.2	1.7	2.3	3.3	4.3	5.7	7.4	9.5
9	0.0	0.0	0.0	0.0	0.0	0.0	0.0	0.0	0.0	0.0
11	0.5	0.8	1.0	1.5	1.9	2.6	3.3	4.2	4.9	5.8
13	0.5	0.7	0.9	1.3	1.6	2.2	2.7	3.4	3.7	4.0
15	0.0	0.0	0.0	0.0	0.0	0.0	0.0	0.0	0.0	0.0
17	0.4	0.6	0.7	0.9	1.2	1.5	1.6	1.9	1.5	1.3
19	0.4	0.5	0.6	0.8	0.9	1.1	1.1	1.3	0.8	0.7
21	0.0	0.0	0.0	0.0	0.0	0.0	0.0	0.0	0.0	0.0
23	0.3	0.4	0.4	0.5	0.5	0.5	0.4	0.4	0.5	0.7
25	0.2	0.3	0.3	0.3	0.4	0.3	0.2	0.3	0.5	0.7
27	0.0	0.0	0.0	0.0	0.0	0.0	0.0	0.0	0.0	0.0
29	0.1	0.2	0.2	0.2	0.1	0.2	0.2	0.3	0.4	0.4
31	0.1	0.1	0.1	0.1	0.1	0.2	0.3	0.3	0.3	0.3
33	0.0	0.0	0.0	0.0	0.0	0.0	0.0	0.0	0.0	0.0
35	0.1	0.1	0.1	0.1	0.1	0.2	0.2	0.2	0.2	0.3
37	0.0	0.1	0.1	0.1	0.1	0.2	0.2	0.1	0.2	0.2
39	0.0	0.0	0.0	0.0	0.0	0.0	0.0	0.0	0.0	0.0
40	0.0	0.0	0.0	0.0	0.0	0.0	0.0	0.0	0.0	0.0
Total RMS Current (A)	1.5	2.1	2.8	4.0	5.1	7.4	9.5	12.4	16.0	20.6
THD (V) %	0.1634	0.2209	0.2817	0.3569	0.4444	0.5886	0.7107	0.8896	1.0127	1.2138

Chapter 10 CERTIFICATION FOR THE DRIVE

Requirements for EMC Compliance

Earthing Requirements

IMPORTANT: Protective earthing always takes precedence over EMC earthing.

Protective Earth (PE) Connections

Note: In accordance with installations to EN60204, only one protective earth conductor is permitted at each protective earth terminal contacting point.

Local wiring regulations may require the protective earth connection of the motor to be connected locally, i.e. not as specified in these instructions. This will not cause shielding problems because of the relatively high RF impedance of the local earth connection.

EMC Earth Connections

For compliance with EMC requirements, the “0V/signal ground” is to be separately earthed. When a number of units are used in a system, these terminals should be connected together at a single, local earthing point.

Control and signal cables connections should be made with screened cables, with the screen connected only at the VSD end. However, if high frequency noise is still a problem, earth screen at the non VSD end via a 0.1µF capacitor.

Note: Connect the screen (at the VSD end) to the VSD protective earth point, and not to the control board terminals.

Requirements for UL Compliance

Solid-State Motor Overload Protection

These devices provide Class 10 motor overload protection. The maximum internal overload protection level (current limit) is 150% for 30 seconds.

An external motor overload protective device must be provided by the installer where the motor has a full-load ampere rating of less than 50% of the drive output rating; or when the DISABLE STALL trip (^SSTLL) is set to True (1); or when the STALL TIME parameter is increased above 480 seconds (refer to the 650V Software Manual, Chapter 1 : STALL TRIP).

Motor over temperature sensing is required. Motors used in conjunction with the drive controller shall be protected with PTC sensor(s) or relays suitable for use with the variable speed drive. Technical details can be found in Chapter 3 Installing the Drive.

Short Circuit Rating

The following drives are suitable for use on a circuit capable of delivering not more than:

220-240V product, 1φ - 5000 RMS Symmetrical Amperes
 220-240V product, 3φ - 7500 RMS Symmetrical Amperes
 380-460V product, 3φ - 10000 RMS Symmetrical Amperes

Solid-State Short-Circuit Protection

These devices are provided with Solid-State Short-Circuit (output) Protection. Branch circuit protection requirements must be in accordance with the latest edition of the National Electrical Code NEC/NFPA-70.

Recommended Branch Circuit Protection

It is recommended that UL Listed (JDDZ) non-renewable cartridge fuses, Class K5 or H; or UL Listed (JDRX) renewable cartridge fuses, Class H, are installed upstream of the drive.

Motor Base Frequency

The motor base frequency rating is 240Hz maximum.

Field Wiring Temperature Rating

Use 75°C Copper conductors only.

Field Wiring Terminal Markings

For correct field wiring connections that are to be made to each terminal refer to Chapter 3: “Installing the Drive” - Wiring Guidelines.

Terminal Tightening Torque

Refer to Chapter 3: “Installing the Drive” – Terminal Tightening Torque.

Terminal/Wire Sizes

North American wire sizes (AWG) are based on NEC/NFPA-70 for ampacities of thermoplastic-insulated (75°C) copper conductors.

Power input and output wire sizes should allow for an ampacity of 125% of the rated input and output amperes for motor branch-circuit conductors as specified in NEC/NFPA-70. Refer to Chapter 3: “Installing the Drive” – Terminal Block Acceptance Sizes.

Input Fuse Ratings

If fitted, fuses should be in accordance with NEC/NFPA-70.

FRAME 1 : 1-Phase (IT/TN), 230V		
Drive Power (kW/hp)	Input Current @ 5kA	Supply Fuse Rating (A) 10 x 38mm
	(A)	
0.25/0.3	4.2	10
0.37/0.5	6.2	10
0.55/0.75	7.9	10
0.75/1.0	10.5	15
FRAME 2 : 1-Phase (IT/TN), 230V		
Drive Power (kW/hp)	Input Current @ 5kA	Supply Fuse Rating (A) 10 x 38mm
	(A)	
1.1/1.5	13.8	20
1.5/2.0	16.0	20
FRAME 2 : 3-Phase (IT/TN), 400V		
Drive Power (kW/hp)	Input Current @ 10kA	Supply Fuse Rating (A) 10 x 38mm
	(A)	
0.37/0.5	2.5	10
0.55/0.75	3.3	10
0.75/1.0	4.1	10
1.1/1.5	5.9	10
1.5/2.0	7.5	10
2.2/3.0	9.4	15
FRAME 3 : 1-Phase (IT/TN), 230V		
Drive Power (kW/hp)	Input Current @ 7.5kA	Supply Fuse Rating (A) 10 x 38mm
	(A)	
2.2/3.0	22.0	30
FRAME 3 : 3-Phase (IT/TN), 230V		
Drive Power (kW/hp)	Input Current @ 7.5kA	Supply Fuse Rating (A) 10 x 38mm
	(A)	
2.2/3.0	14.3	20
3.0/4.0	18.1	25
4.0/5.0	23.1	30
FRAME 3 : 3-Phase (IT/TN), 400V		
Drive Power (kW/hp)	Input Current @ 10kA	Supply Fuse Rating (A) 10 x 38mm
	(A)	
3.0/4	11.1	15
4.0/5	13.9	20
5.5/7.5	18.0	25
7.5/10	23.6	30

10-3 Certification for the Drive

Field Grounding Terminals

The field grounding terminals are identified with the International Grounding Symbol (IEC Publication 417, Symbol 5019).



Operating Ambient Temperature

Devices are considered acceptable for use in a maximum ambient temperature of 40°C (can be derated up to 50°C).

European Directives and the CE Mark

CE Marking for Low Voltage Directive

When installed in accordance with this manual, the 650V AC Drive is CE marked by Parker SSD Drives Ltd in accordance with the low voltage directive (S.I. No. 3260 implements this LVD directive into UK law). An EC Declaration of Conformity (low voltage directive) is included at the end of this chapter.

CE Marking for EMC - Who is Responsible?

Note: *The specified EMC emission and immunity performance of this unit can only be achieved when the unit is installed to the EMC Installation Instructions given in this manual.*

According to S.I. No. 2373 which implements the EMC directive into UK law, the requirement for CE marking this unit falls into two categories:

1. Where the supplied unit has an intrinsic/direct function to the end user, then the unit is classed as **relevant apparatus**. In this situation the responsibility for certification rests with Parker SSD Drives. The Declaration of Conformity is included at the end of this Chapter.
2. Where the supplied unit is incorporated into a higher system/apparatus or machine which includes (at least) the motor, cable and a driven load but is unable to function without this unit, then the unit is classed as a **component**. In this circumstance, the responsibility rests with the manufacturer/supplier/installer of the system/apparatus/machine.

EMC Compliance

All Models All models are compliant with BS EN61800-3.	
Radiated Emissions	EN50081-1(1992) and EN61800-3 unrestricted distribution when mounted inside the specified cubicle, see above. Control and motor cables must be screened and correctly fitted with glands where they exit the cubicle. Control 0V must be connected to protective earth/ground.
Immunity	EN50082-1 (1997), EN61800-3 (1997), EN61000-6-2 (1999)
FRAME 1 & 2: 1-Phase (TN only),	
Conducted Emissions	EN50081-1(1992), EN61800-3 unrestricted distribution, maximum motor cable length: 25m
FRAME 2 & 3 : 3-Phase, FRAME 3 : 1-Phase (TN only)	
Conducted Emissions	EN50081-2(1993), EN61800-3 restricted distribution maximum motor cable length: 25m

Certificates

650V 0.25 - 4.0kW 230V



EC DECLARATIONS OF CONFORMITY

Date CE marked first applied: 26/07/2001

EMC Directive

In accordance with the EEC Directive 2004/108/EC

We Parker SSD Drives, address as below, declare under our sole responsibility that the above Electronic Products when installed and operated with reference to the instructions in the Product Manual (provided with each piece of equipment) is in accordance with the relevant clauses from the following standard:-

BSEN61800-3 (2004)

Low Voltage Directive

In accordance with the EEC Directive 2006/95/EC

We Parker SSD Drives, address as below, declare under our sole responsibility that the above Electronic Products when installed and operated with reference to the instructions in the Product Manual (provided with each piece of equipment), is in accordance with the following standard :-

EN61800-5 (2007)

Issued for compliance with the EMC Directive when the unit is used as *relevant apparatus*.

The drive is CE marked in accordance with the low voltage directive for electrical equipment and appliances in the voltage range when installed correctly.

MANUFACTURERS DECLARATIONS

EMC Declaration

We Parker SSD Drives, address as below, declare under our sole responsibility that the above Electronic Products when installed and operated with reference to the instructions in the Product Manual (provided with each piece of equipment) is in accordance with the relevant clauses from the following standard:-

BSEN61800-3 (2004)

Machinery Directive

The above Electronic Products are components to be incorporated into machinery and may not be operated alone.

The complete machinery or installation using this equipment may only be put into service when the safety considerations of the Directive 2006/42/EC are fully adhered to.

Particular reference should be made to EN60204-1 (Safety of Machinery - Electrical Equipment of Machines).

All instructions, warnings and safety information of the Product Manual must be adhered to.

This is provided to aid your justification for EMC compliance when the unit is used as a component.

Since the potential hazards are mainly electrical rather than mechanical, the drive does not fall under the machinery directive. However, we do supply a manufacturer's declaration for when the drive is used(as a component) in machinery.

Dr Martin Payn (Conformance Officer)

Parker Hannifin Ltd., Automation Group, SSD Drives Europe

NEW COURTWICK LANE, LITTLEHAMPTON, WEST SUSSEX BN17 7RZ

TELEPHONE: +44(0)1903 737000 FAX: +44(0)1903 737100

Registered Number: 4806503 England. Registered Office: 55 Maylands Avenue, Hemel Hempstead, Herts HP2 4SJ

10-5 Certification for the Drive

650V 0.37 -7.5kW 400V



EC DECLARATIONS OF CONFORMITY

Date CE marked first applied: 26/07/2001

EMC Directive

In accordance with the EEC Directive 2004/108/EC

We Parker SSD Drives, address as below, declare under our sole responsibility that the above Electronic Products when installed and operated with reference to the instructions in the Product Manual (provided with each piece of equipment) is in accordance with the relevant clauses from the following standard:-

BSEN61800-3 (2004)

Low Voltage Directive

In accordance with the EEC Directive 2006/95/EC

We Parker SSD Drives, address as below, declare under our sole responsibility that the above Electronic Products when installed and operated with reference to the instructions in the Product Manual (provided with each piece of equipment), is in accordance with the following standard :-

EN50178 (1998)

Issued for compliance with the EMC Directive when the unit is used as *relevant apparatus*.

The drive is CE marked in accordance with the low voltage directive for electrical equipment and appliances in the voltage range when installed correctly.

MANUFACTURERS DECLARATIONS

EMC Declaration

We Parker SSD Drives, address as below, declare under our sole responsibility that the above Electronic Products when installed and operated with reference to the instructions in the Product Manual (provided with each piece of equipment) is in accordance with the relevant clauses from the following standard:-

BSEN61800-3 (2004)

Machinery Directive

The above Electronic Products are components to be incorporated into machinery and may not be operated alone.

The complete machinery or installation using this equipment may only be put into service when the safety considerations of the Directive 2006/42/EC are fully adhered to.

Particular reference should be made to EN60204-1 (Safety of Machinery - Electrical Equipment of Machines).

All instructions, warnings and safety information of the Product Manual must be adhered to.

This is provided to aid your justification for EMC compliance when the unit is used as a component.

Since the potential hazards are mainly electrical rather than mechanical, the drive does not fall under the machinery directive. However, we do supply a manufacturer's declaration for when the drive is used(as a component) in machinery.

Dr Martin Payn (Conformance Officer)

Parker Hannifin Ltd., Automation Group, SSD Drives Europe

NEW COURTWICK LANE, LITTLEHAMPTON, WEST SUSSEX BN17 7RZ

TELEPHONE: +44(0)1903 737000 FAX: +44(0)1903 737100

Registered Number: 4806503 England. Registered Office: 55 Maylands Avenue, Hemel Hempstead, Herts HP2 4SJ

Chapter 11 SERIAL COMMUNICATIONS

Connection to the P3 Port

IMPORTANT: The drive **MUST** be earthed. Failure to do so could damage your communications ports.

The port is an un-isolated RS232, 19200 Baud, supporting the standard EIA bisynch ASCII communications protocol. Contact Parker SSD Drives for further information.

The P3 port is located under the terminal cover and can be used for pc configuration or to remote mount a RS232 keypad.

P3 Port

A standard P3 lead is used to connect to the drive.

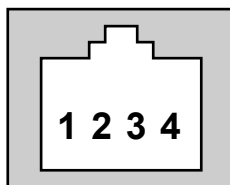

P3 Port Pin	Lead	Signal
1	Black	0V
2	Red	5V
3	Green	TX
4	Yellow	RX

Note: There is 5V present on pin 2 of the P3 port - do not connect this to your PC.

Chapter 12 APPLICATIONS

The Default Application

The drive is supplied with 6 Applications, Application 0 to Application 5. Each Application recalls a pre-programmed structure of internal links when it is loaded.

DEFAULT

- Application 0 will not control a motor. Loading Application 0 removes all internal links.
- Application 1 is the factory default application, providing for basic speed control
- Application 2 supplies speed control using a manual or auto setpoint
- Application 3 supplies speed control using preset speeds
- Application 4 is a set-up providing speed control with Raise/Lower Trim
- Application 5 supplies speed control with Run Forward/Run Reverse
- Application 6 provides for basic speed control with convenient sequencing over comms.

IMPORTANT: Refer to Chapter 5: The Keypad – Special Menu Features to reset the drive to factory default values which are suitable for most applications.

How to Load an Application

In the **PRG** menu, go to **P I** and press the **M** key twice.

The Applications are stored in this menu.

Use the **▲** **▼** keys to select the appropriate Application by number.

Press the **E** key to load the Application.

Application Description

Control Wiring for Applications

The large Application Diagrams on the following pages show the full wiring for push-button starting. The diagrams on the reverse show the full wiring for single wire starting.

For the minimum connections to make the drive run refer to Chapter 3: "Installing the Drive" - Electrical Installation; the remaining connections can be made to suit your system.

When you load an Application, the input and output parameters shown in these diagrams default to the settings shown. For alternative user-settings refer to the Software Product Manual, Chapter 1 "Programming Your Application".

Key to Application Diagrams

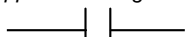

normally open contact (relay)

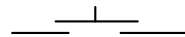

normally open push-button

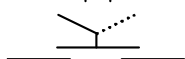

2-position switch



normally closed push-button

12-3 Applications

Application 1: Basic Speed Control (default)

This Application is ideal for general purpose applications. It provides push-button or switched start/stop control. The setpoint is the sum of the two analogue inputs AIN1 and AIN2, providing Speed Setpoint + Speed Trim capability.

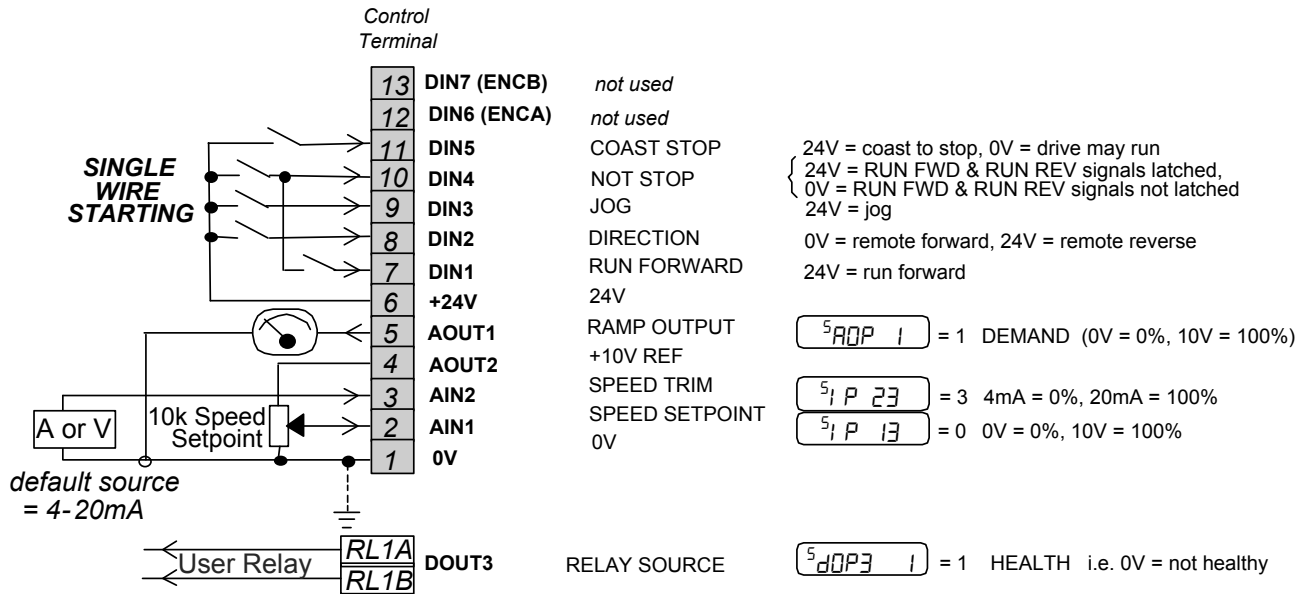

Application 2 : Auto/Manual Control

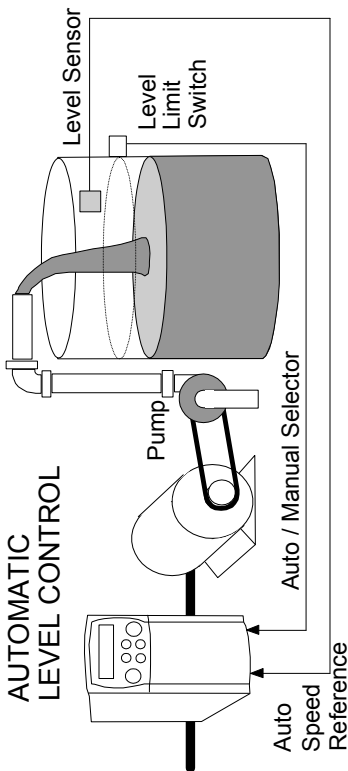

Application 2: Auto/Manual Control

IDEAL FOR AUTOMATIC CONTROL APPLICATIONS
WITH LIMIT SWITCHES OR PROXIMITY TRANSDUCERS

P1 = 2

Italic text indicates Default

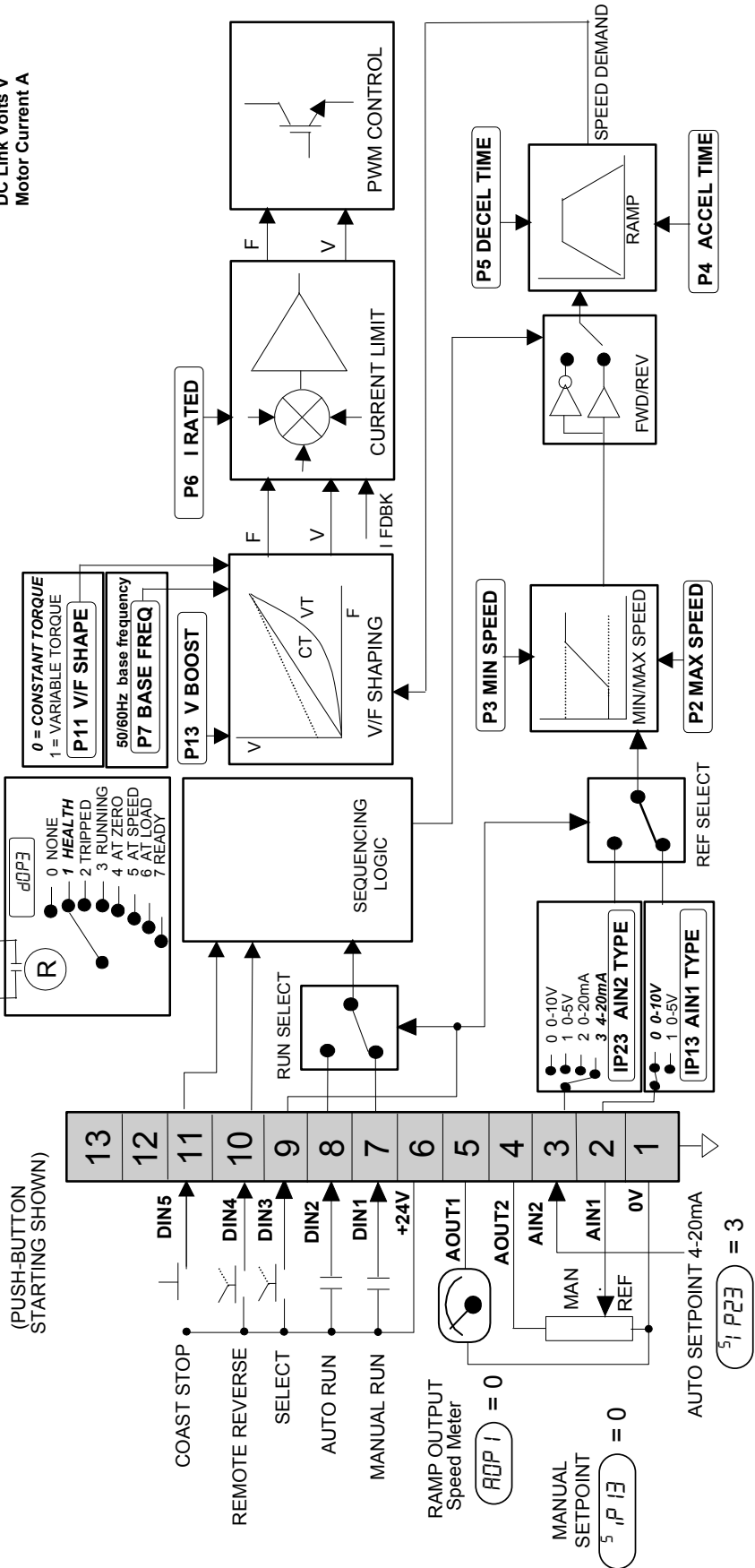

- STANDARD PARAMETERS**
- p1 Application
 - p2 Max speed
 - p3 Min speed
 - p4 Accel time
 - p5 Decel time
 - p6 Motor current
 - p7 Base frequency
 - p8 Jog setpoint
 - p9 Run stop mode
 - p11 V/F shape
 - p12 Normal duty
 - p13 Fixed boost, (VF only)
 - p99 Password

DIAGNOSTICS

- Frequency Hz
- Speed Setpt %
- DC Link Volts V
- Motor Current A

12-5 Applications

Application 2: Auto/Manual Control

Two Run inputs and two Setpoint inputs are provided. The Auto/Manual switch selects which pair of inputs is active. The Application is sometimes referred to as Local/Remote.

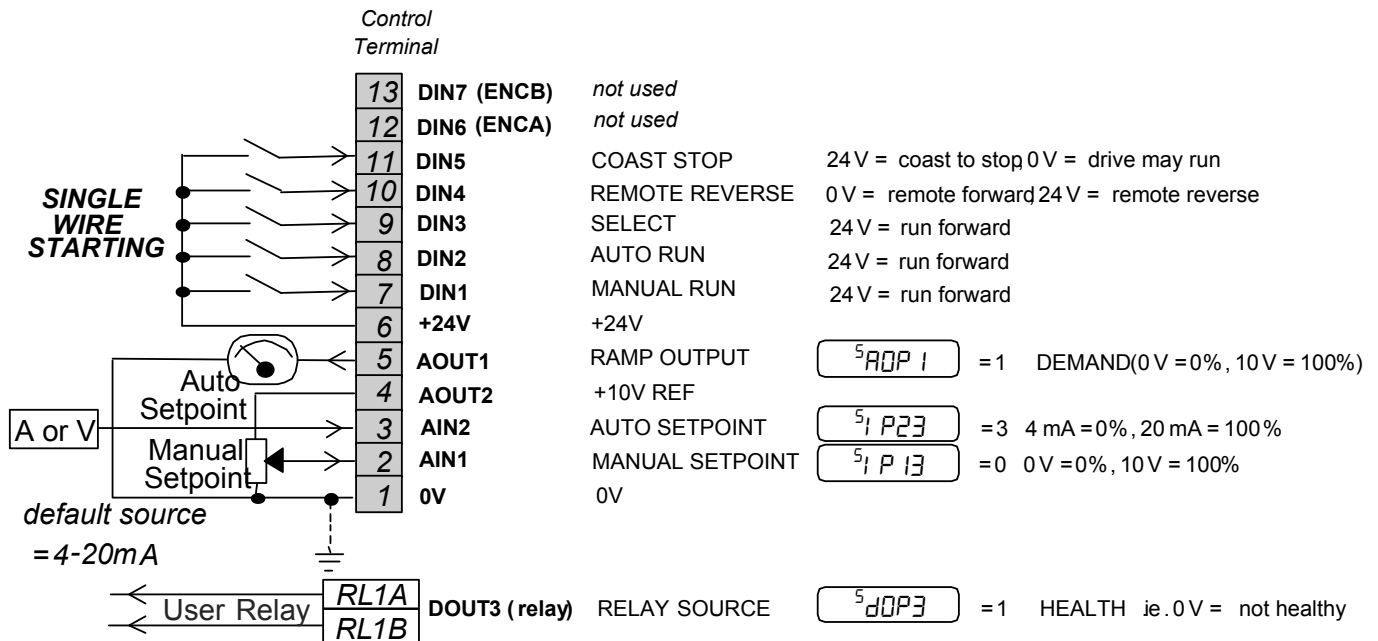

Application 3 : Preset Speeds

STANDARD PARAMETERS

- p1 Application
- p2 Max speed
- p3 Min speed
- p4 Accel time
- p5 Decel time
- p6 Motor current
- p7 Base frequency
- p8 Jog setpoint
- p9 Run Stop mode
- p11 V/F shape
- p12 Normal duty
- p13 Fixed boost, (VF only)
- p99 Password

DIAGNOSTICS

- Frequency Hz
- Speed Setpoint %
- DC Link Volts V
- Motor Current A

Application 3: Preset Speeds

IDEAL FOR APPLICATIONS REQUIRING
MULTIPLE DISCRETE SPEED LEVELS

P = 3

Italic text indicates Default

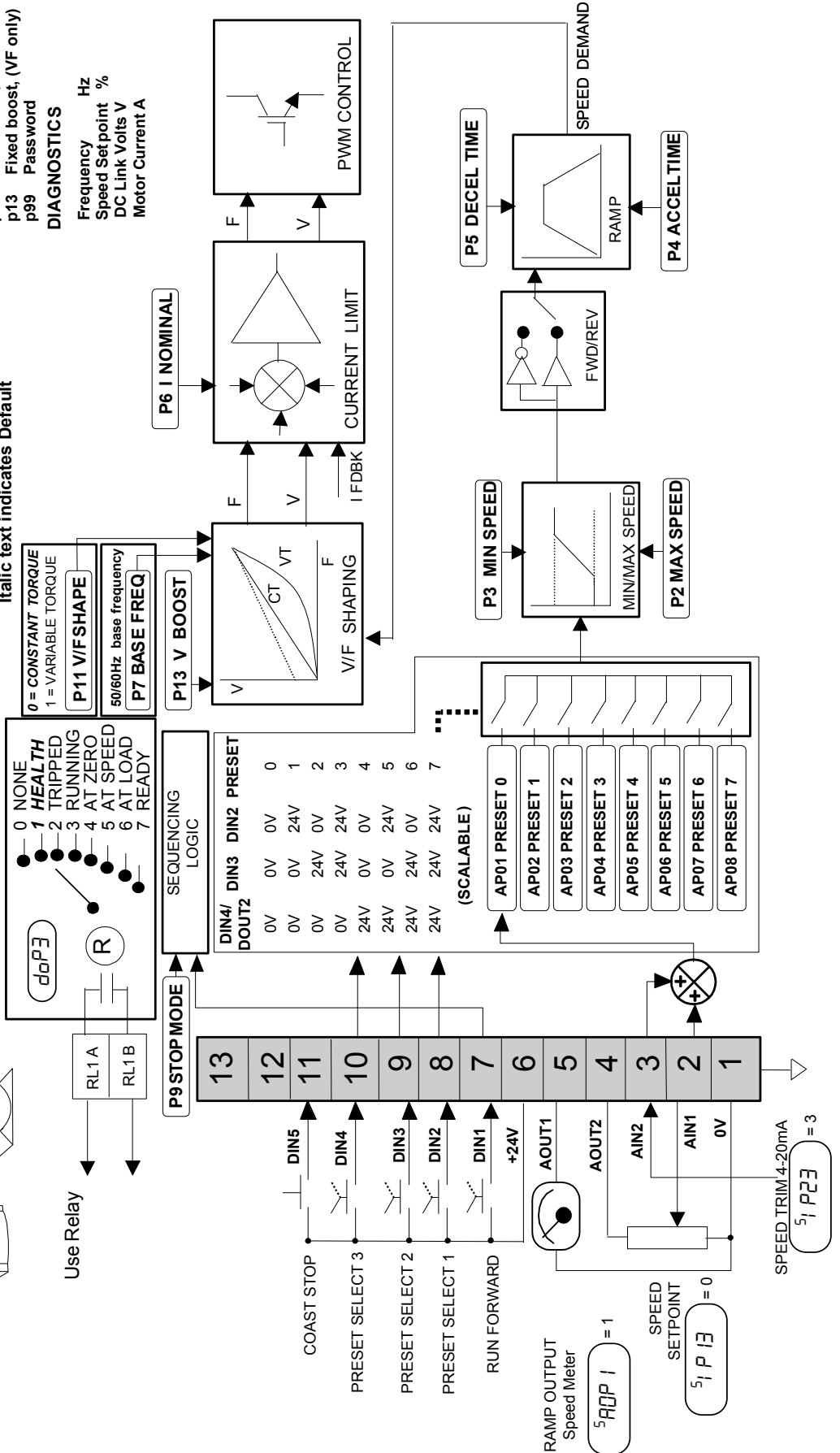
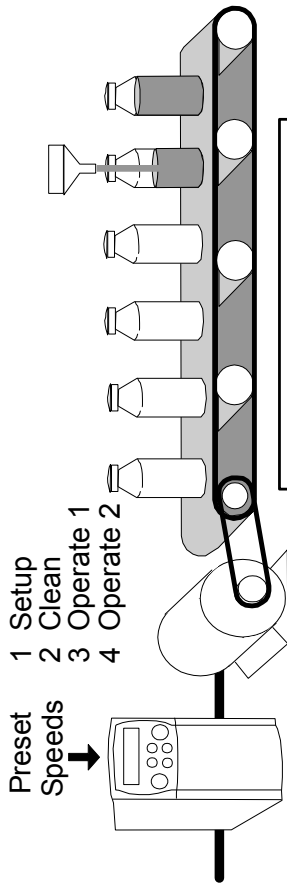

12-7 Applications

Application 3: Preset Speeds

This is ideal for applications requiring multiple discrete speed levels.

The setpoint is selected from either the sum of the analogue inputs, (as in Application 1 and known here as PRESET 0), or as one of up to seven other pre-defined speed levels. These are selected using DIN2, DIN3 and DIN4, refer to the Truth Table below.

Edit parameters AP2 to AP8 on the keypad to re-define the speed levels of PRESET 1 to PRESET 7. Reverse direction is achieved by entering a negative speed setpoint.

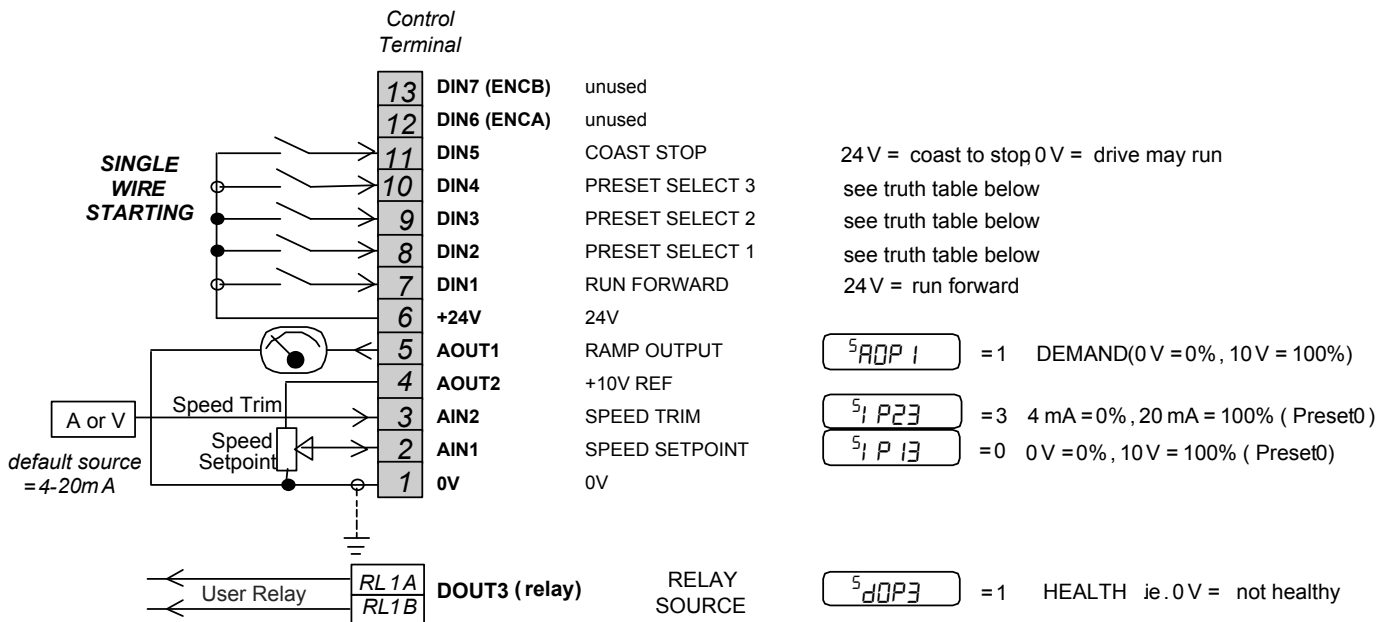

Preset Speed Truth Table

DIN4	DIN3	DIN2	Preset
0V	0V	0V	0
0V	0V	24V	1
0V	24V	0V	2
0V	24V	24V	3
24V	0V	0V	4
24V	0V	24V	5
24V	24V	0V	6
24V	24V	24V	7

Application 4 : Raise/Lower Trim

Application 4: Raise/Lower Trim

STANDARD PARAMETERS

- p1 Application
- p2 Max speed
- p3 Min speed
- p4 Accel time
- p5 Decel time
- p6 Motor current
- p7 Base frequency
- p8 Jog setpoint
- p9 Run stop mode
- p11 V/F shape
- p12 Normal duty
- p13 Fixingboost, (VF only)
- p99 Password

DIAGNOSTIC

- Frequency Hz
- Speed Setpoint %
- DC Link Volts V
- Motor Current A

IDEAL FOR APPLICATIONS REQUIRING
SPEED CONTROL FROM MULTIPLE LOCATIONS

P *I* = 4

Italic text indicates Default

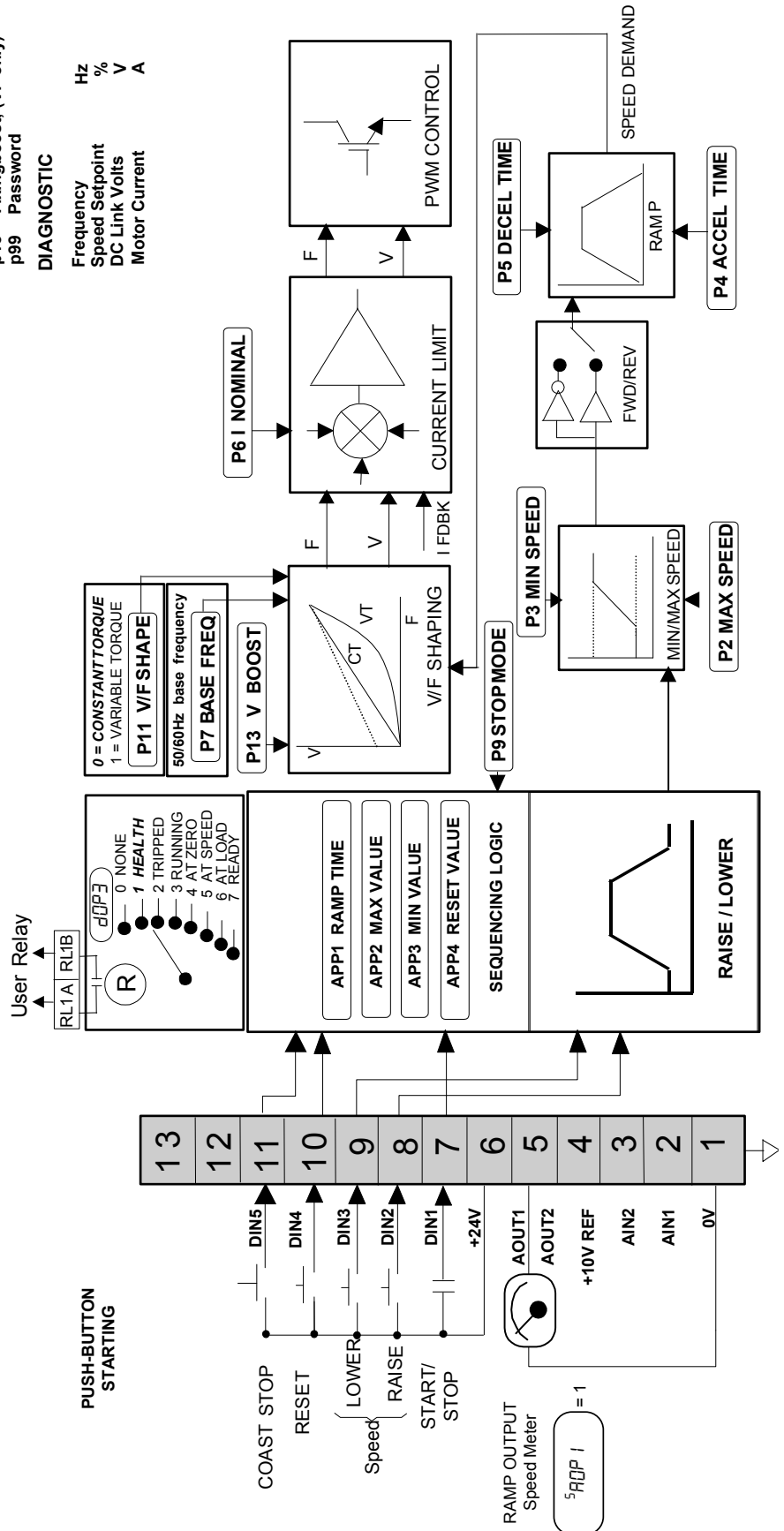
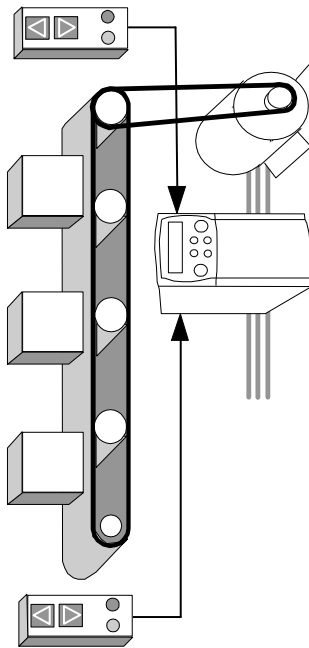

12-9 Applications

Application 4: Raise/Lower Trim

This Application mimics the operation of a motorised potentiometer. Digital inputs allow the setpoint to be increased and decreased between limits. The limits and ramp rate can be set using the keypad.

The Application is sometimes referred to as Motorised Potentiometer.

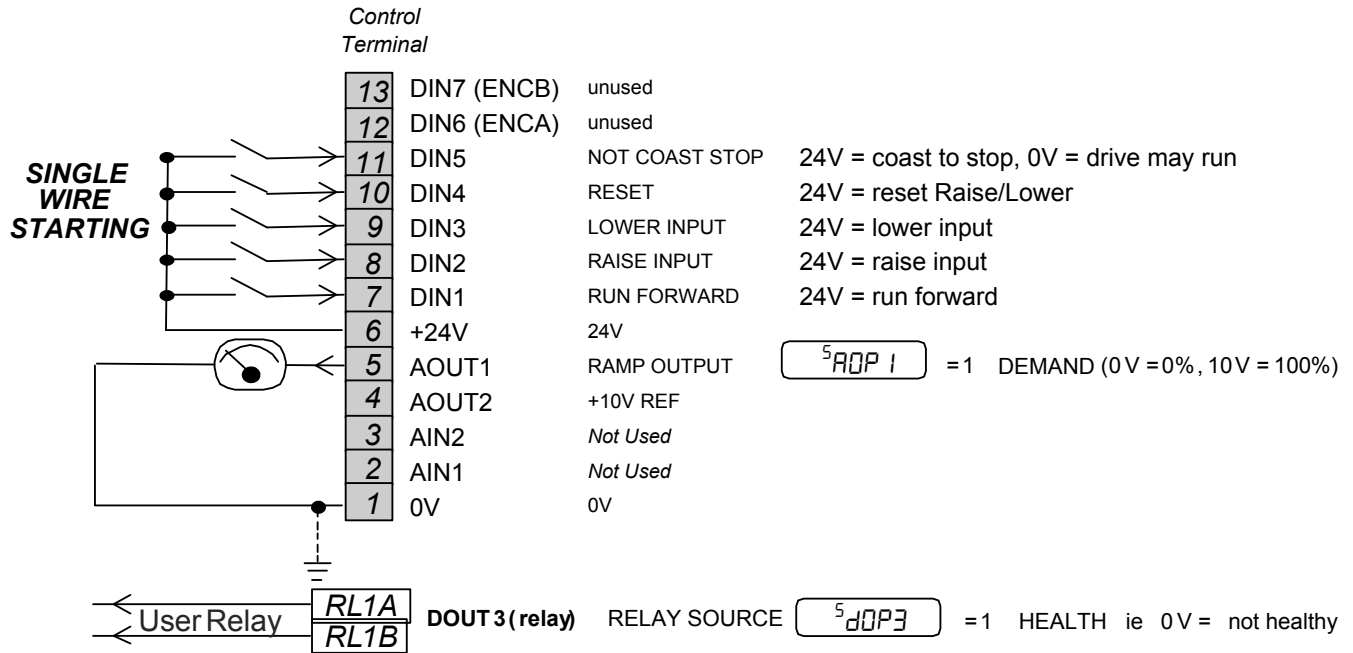

Application 5 : PID

STANDARD PARAMETERS

- p1 Application
- p2 Max speed
- p3 Min speed
- p4 Accel time
- p5 Decel time
- p6 Motor current
- p7 Base frequency
- p8 Jog setpoint
- p9 Run stop mode
- p11 V/F shape
- p12 Normal duty
- p13 Fixingboost, (VF only)
- p99 Password

DIAGNOSTIC

- Frequency Hz
- Speed Setpoint %
- DC Link Volts V
- Motor Current A

Application 5: PID Control

EASY TUNING FOR SETPOINT/FEEDBACK CONTROL APPLICATIONS REGULATING VOLUME OR PRESSURE, SUCH AS AIR HANDLING OR PUMPING

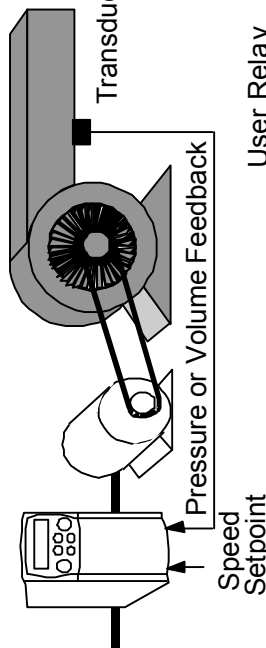

P I = 5

Italic text indicates Default

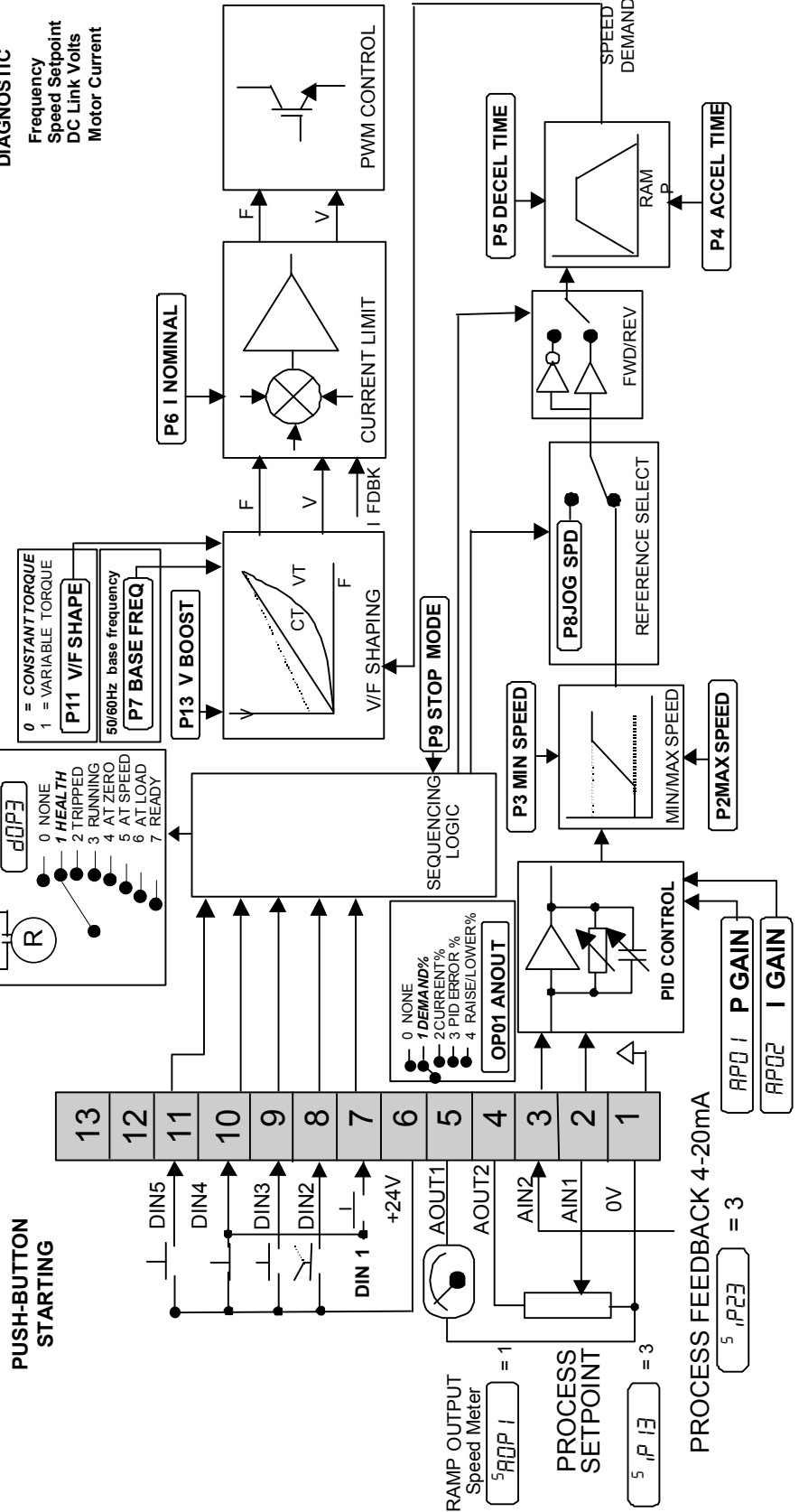

12-11 Applications

Application 5: PID

A simple application using a Proportional-Integral-Derivative 3-term controller. The setpoint is taken from AIN1, with feedback signal from the process on AIN2. The scale and offset features of the analogue input blocks may be used to correctly scale these signals. The difference between these two signals is taken as the PID error. The output of the PID block is then used as the drive setpoint.

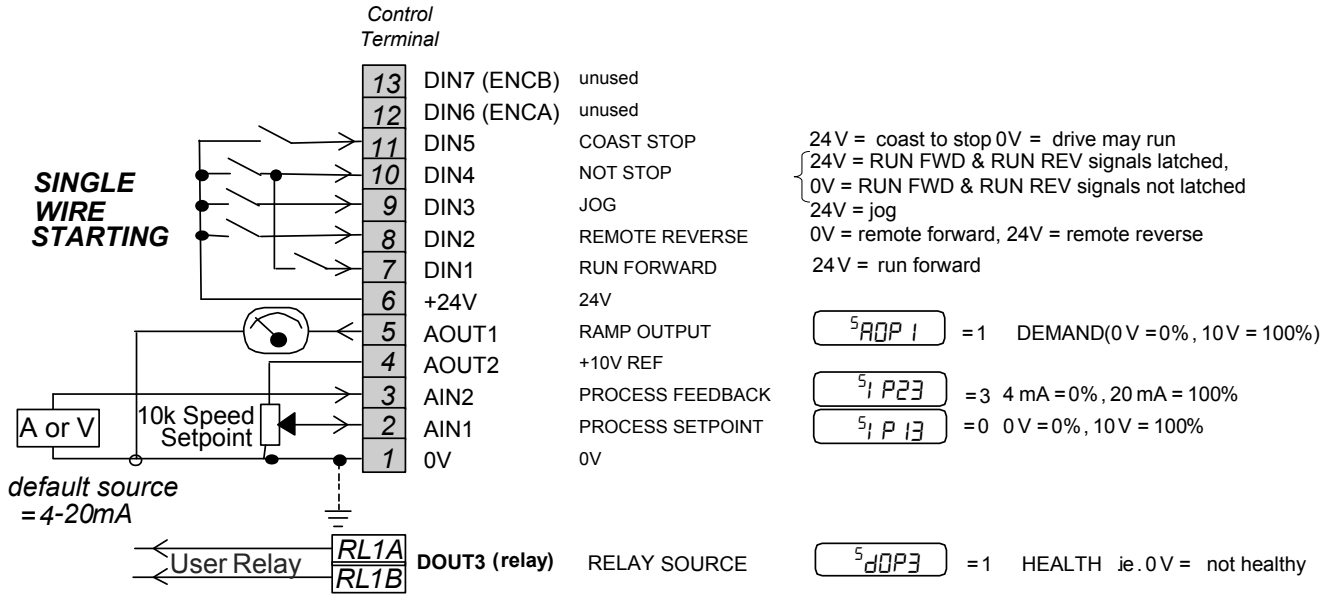

Application 6 : Auxilliary Comms

STANDARD PARAMETERS

- p1 Application
 - p2 Max speed
 - p3 Min speed
 - p4 Accel time
 - p5 Decel time
 - p6 Motor rated current
 - p7 Base frequency
 - p8 Jog setpoint
 - p9 Stop mode
 - p11 V/F shape
 - p12 Normal duty
 - p13 Fixed boost, (VF only)
 - p99 Password
- DIAGNOSTICS**
- Frequency Hz
 - Speed Setpt %
 - DC Link Volts V
 - Motor Current A

Application 6: Auxiliary Comms

IDEAL FOR GENERAL PURPOSE ALLICATIONS,
NORMAL DUTY AND HEAVY DUTY

P *i* = 6

Italic text indicates Default

User Relay

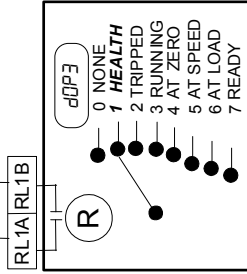

- 0 = CONSTANT TORQUE**
- 1 = VARIABLE TORQUE**
- P11 VFSHAPE**
50/60Hz base frequency
- P7 BASE FREQ**
- P13 V BOOST**

P6 I NOMINAL

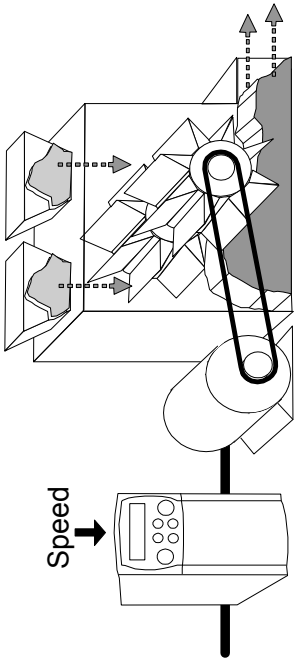
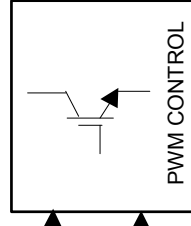
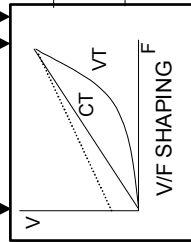

PUSH-BUTTON STARTING

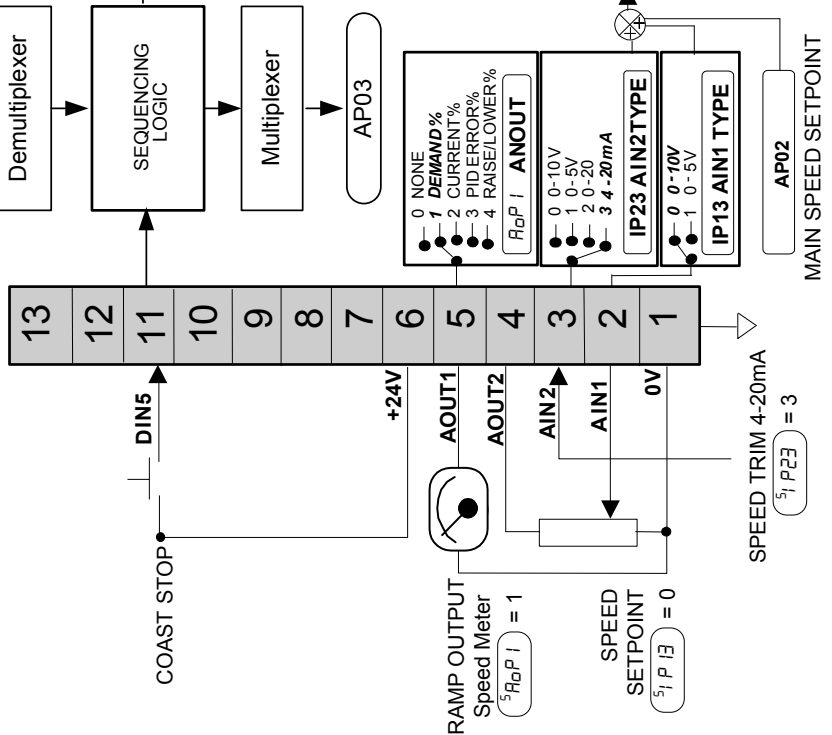

P3 MIN SPEED

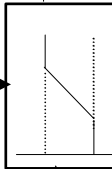

P2 MAX SPEED

PRESET1 INPUT1

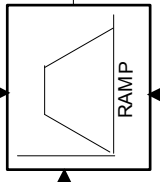

PRESET1 INPUT1

FWD/REV

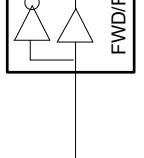

SPEED DEMAND

12-13 Applications

Application 6: AUXILIARY COMMS

General purpose implementation of basic speed control, with sequencing and speed reference conveniently controlled and monitored (via just 3 parameters) over comms.

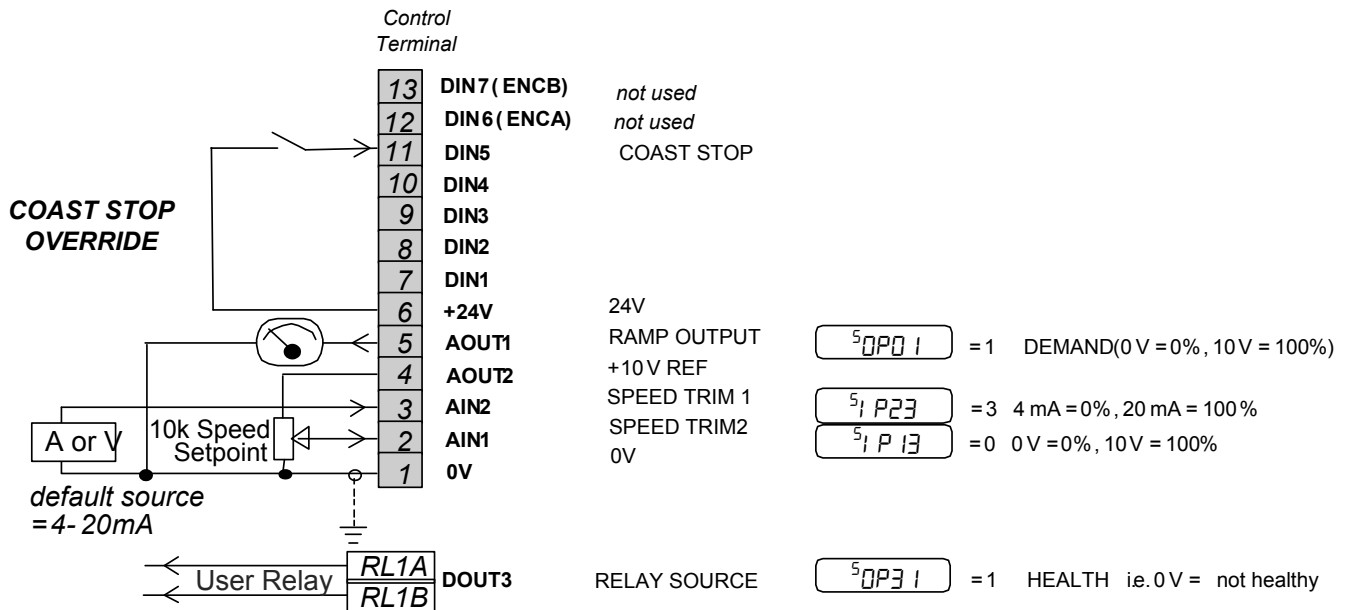

AP01 (Tag 599)

Mask	Function
Bit 4	Jog
Bit 3	Trip reset
Bit 2	Reverse
Bit 1	Enable
Bit 0	Run forward

AP03 (Tag 598)

Mask	Diagnostic
Bit 13	At speed
Bit 12	Zero speed
Bit 11	Ramping
Bit 10	Fan running
Bit 9	Healthy
Bit 8	Reversed
Bit 7	System reset
Bit 6	Ready
Bit 5	Switched on
Bit 4	Switch on enabled
Bit 3	Stopping
Bit 2	Jogging
Bit 1	Running
Bit 0	Tripped

Parker Worldwide

AE – UAE, Dubai
Tel: +971 4 8127100
parker.me@parker.com

AR – Argentina, Buenos Aires
Tel: +54 3327 44 4129

AT – Austria, Wiener Neustadt
Tel: +43 (0)2622 23501-0
parker.austria@parker.com

AT – Eastern Europe,
Wiener Neustadt
Tel: +43 (0)2622 23501 900
parker.easteurope@parker.com

AU – Australia, Castle Hill
Tel: +61 (0)2-9634 7777

AZ – Azerbaijan, Baku
Tel: +994 50 2233 458
parker.azerbaijan@parker.com

BE/LU – Belgium, Nivelles
Tel: +32 (0)67 280 900
parker.belgium@parker.com

BR – Brazil, Cachoeirinha RS
Tel: +55 51 3470 9144

BY – Belarus, Minsk
Tel: +375 17 209 9399
parker.belarus@parker.com

CA – Canada, Milton, Ontario
Tel: +1 905 693 3000

CH – Switzerland, Etoy
Tel: +41 (0)21 821 87 00
parker.switzerland@parker.com

CL – Chile, Santiago
Tel: +56 2 623 1216

CN – China, Shanghai
Tel: +86 21 2899 5000

CZ – Czech Republic, Klecany
Tel: +420 284 083 111
parker.czechrepublic@parker.com

DE – Germany, Kaarst
Tel: +49 (0)2131 4016 0
parker.germany@parker.com

DK – Denmark, Ballerup
Tel: +45 43 56 04 00
parker.denmark@parker.com

ES – Spain, Madrid
Tel: +34 902 330 001
parker.spain@parker.com

FI – Finland, Vantaa
Tel: +358 (0)20 753 2500
parker.finland@parker.com

FR – France, Contamine s/Arve
Tel: +33 (0)4 50 25 80 25
parker.france@parker.com

GR – Greece, Athens
Tel: +30 210 933 6450
parker.greece@parker.com

HK – Hong Kong
Tel: +852 2428 8008

HU – Hungary, Budapest
Tel: +36 1 220 4155
parker.hungary@parker.com

IE – Ireland, Dublin
Tel: +353 (0)1 466 6370
parker.ireland@parker.com

IN – India, Mumbai
Tel: +91 22 6513 7081-85

IT – Italy, Corsico (MI)
Tel: +39 02 45 19 21
parker.italy@parker.com

JP – Japan, Tokyo
Tel: +81 (0)3 6408 3901

KR – South Korea, Seoul
Tel: +82 2 559 0400

KZ – Kazakhstan, Almaty
Tel: +7 7272 505 800
parker.easteurope@parker.com

MX – Mexico, Apodaca
Tel: +52 81 8156 6000

MY – Malaysia, Shah Alam
Tel: +60 3 7849 0800

NL – The Netherlands,
Oldenzaal
Tel: +31 (0)541 585 000
parker.nl@parker.com

NO – Norway, Asker
Tel: +47 66 75 34 00
parker.norway@parker.com

NZ – New Zealand, Mt Wellington
Tel: +64 9 574 1744

PL – Poland, Warsaw
Tel: +48 (0)22 573 24 00
parker.poland@parker.com

PT – Portugal, Leca da Palmeira
Tel: +351 22 999 7360
parker.portugal@parker.com

RO – Romania, Bucharest
Tel: +40 21 252 1382
parker.romania@parker.com

RU – Russia, Moscow
Tel: +7 495 645-2156
parker.russia@parker.com

SE – Sweden, Spånga
Tel: +46 (0)8 59 79 50 00
parker.sweden@parker.com

SG – Singapore
Tel: +65 6887 6300

SK – Slovakia, Banská Bystrica
Tel: +421 484 162 252
parker.slovakia@parker.com

SL – Slovenia, Novo Mesto
Tel: +386 7 337 6650
parker.slovenia@parker.com

TH – Thailand, Bangkok
Tel: +662 717 8140

TR – Turkey, Istanbul
Tel: +90 216 4997081
parker.turkey@parker.com

TW – Taiwan, Taipei
Tel: +886 2 2298 8987

UA – Ukraine, Kiev
Tel: +380 44 494 2731
parker.ukraine@parker.com

UK – United Kingdom,
Warwick
Tel: +44 (0)1926 317 878
parker.uk@parker.com

US – USA, Cleveland
Tel: +1 216 896 3000

VE – Venezuela, Caracas
Tel: +58 212 238 5422

ZA – South Africa,
Kempton Park
Tel: +27 (0)11 961 0700
parker.southafrica@parker.com

European Product Information Centre
Free phone: 00 800 27 27 5374
(from AT, BE, CH, CZ, DE, EE, ES, FI, FR, IE,
IL, IS, IT, LU, MT, NL, NO, PT, SE, SK, UK)

© 2012 Parker Hannifin Corporation. All rights reserved.



Parker Hannifin Manufacturing Limited
Automation Group, SSD Drives Europe,
New Courtwick Lane
Littlehampton, West Sussex BN17 7RZ
United Kingdom
Tel.: +44 (0) 1903 737000
Fax: +44 (0) 1903 737100
www.parker.com/ssd



* H A 4 6 7 6 4 9 U 0 0 3 0 2 *